

Ventilation system
ComfoD 180 and ComfoAir 180
Manual for the installer

zehnder

always
around you

Heating

Cooling

Fresh Air

Clean Air

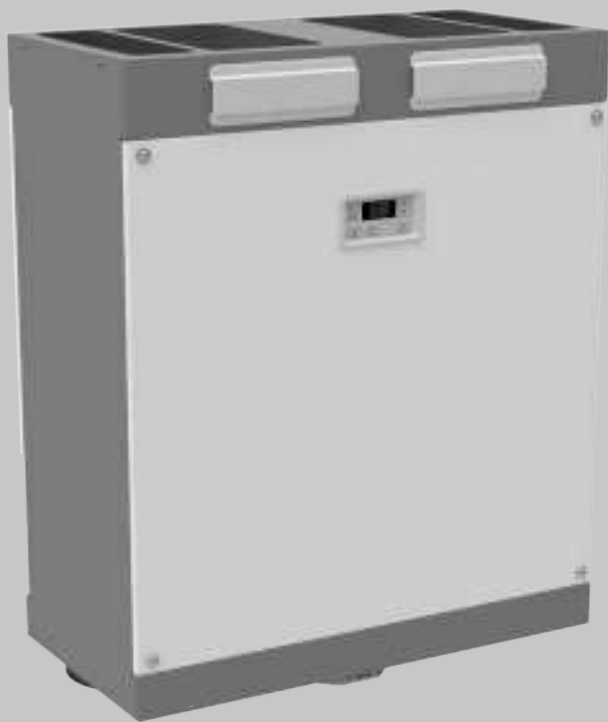

ComfoD / Basic



ComfoAir / Luxe

Foreword

 **Read this document carefully before use.**

This document provides all the information required for safe and optimal installation of the ComfoD 180 and ComfoAir180. In this document they will be referred to as “the unit”.

The unit is subject to continuous development and improvement. As a result, the unit may slightly differ from the descriptions.

The following pictograms are used in this document:

 **Point of attention.**

 **Risk of:**

- **damage to the device;**
- **performance of the device is compromised if instructions are not observed carefully.**

 **Risk of personal injury for the user.**

 **Maintenance**

 **Questions**

Please contact the supplier if you have any questions or would like to order a new document or new filters. The contact details of the main supplier(s) can be found in the user manual.

The following information can be found in the User manual:

Information

General information about the ventilation system.

Operating devices available for the unit.

Warranty and liability conditions.

EEC declaration of conformity.

How to maintain the filters of the unit.

How to maintain the valves of the ventilation system.

The following information can be found in the Service manual:

Information

How to commission the unit

How to use P-menus.

How to maintain the unit

How to solve errors

All rights reserved.

This documentation has been compiled with the utmost care. The publisher cannot be held liable for any damage caused as a result of missing or incorrect information in this document. In case of disputes the English version of these instructions will be binding.

Table of Contents

	Foreword	2
1	Safety	5
2	Installation conditions	5
3	Transport and unpacking	5
4	Technical specifications	6
	4.1 Configuration unit.....	7
	4.2 Dimension sketch	8
	4.3 Wiring diagram	10
5	Installation	12
	5.1 Rework Right to Left version	12
	5.2 Wall mounting, standard	13
	5.3 Wall mounting, restricted height.....	14
	5.4 Wall mounting, restricted height and width	15
	5.5 Air ducts.....	16
	5.5.1 Top air ducts	16
	5.5.2 Bottom supply air duct.....	16
	5.6 Condensation drain	18
	5.6.1 U-bend.....	18
	5.6.2 Dry syphon.....	18
	5.7 Valves and/or grilles	18
	5.8 Extractor hood (optional).....	19
	5.9 External filter (optional).....	19
	5.10 Unregulated sub-soil heat exchanger (optional)	19

1 Safety

Always follow the safety regulations, warnings, comments and instructions given in this document. Personal injury or damage to the unit can arise from non-compliance with the safety regulations, warnings, comments and instructions in this document.

- Only a certified engineer may fit, connect, commission and maintain the unit unless otherwise indicated in this document;
- Installation of the unit must be carried out in accordance with the general and locally applicable construction, safety and installation instructions of the local council, electricity and water boards or other agencies;
- The unit is only suitable for a 230V 50/60Hz connection;
- The unit is only suitable for residential use and not for industrial use, such as swimming pools or saunas;
- Ensure while working on the unit that the power has been controlled off and cannot be accidentally controlled back on;
- Always take ESD-inhibiting measures when dealing with electronics, such as wearing an antistatic wristband;
- After using the user manual, place it back on the unit;
- It is prohibited to modify the unit or the specifications stated in this document;
- The unit cannot be opened without using tools;
- It must not be possible to touch the fans by hand, which is why ducts of at least 900 mm must be connected to the unit.

2 Installation conditions

In order to determine whether the unit can be installed in a certain area, the following aspects must be taken into account:

- The system must be fitted to allow sufficient room around the unit for the air duct connections, condensation drain as well as for carrying out maintenance activities;
- The unit must be installed in a frost-free space;
- We do not recommend installing the unit in areas with a higher than average humidity (such as bathroom or wc). This will prevent condensation on the outside of the unit;
- The room must offer the following provisions:
 - Air duct connections;
 - Electrical power connection;
 - Wiring for a wired control controller;
 - Provisions for the condensation drain.

3 Transport and unpacking



Take the necessary precautions when transporting and unpacking the unit and make sure the packing material is disposed of in an environmentally friendly manner.

Checking the delivery

Contact your supplier immediately in case of damage or an incomplete delivery. The delivery should at least include:

- The unit: check the identification plate to ensure that it is the required type;
- 2 Mounting brackets;
- 6 Spacers;
- Service/ComfoSense connector;
- Documentation.

Meaning of the suffixes found on the identification plate

- ComfoAir = Product family name.
- ComfoD = The unit has a display installed as default.
- 180 = Product type name (Air volumes in m³/h)
- Basic = The unit has a display installed as default.
- Luxe = The unit has no display installed as default.
- Enthalpie = The unit has an enthalpy exchanger installed as default.
- ERV = The unit has an enthalpy exchanger installed as default.
- PH = The unit has a pre heater installed as default.
- V = The unit has a pre heater installed as default.

4 Technical specifications

Position	Ventilation capacity	Power	Current	Silencer housing	Sound power ¹ Supply fan	Sound power ¹ Exhaust fan
15%	28 m ³ /h at 3 Pa	7 W	0.08 A	27.2 dB(A)	39 dB(A)	38 dB(A)
20%	37 m ³ /h at 6 Pa	8 W	0.09 A	27.8 dB(A)	40 dB(A)	39 dB(A)
30%	55 m ³ /h at 14 Pa	10 W	0.10 A	29.8 dB(A)	42 dB(A)	40 dB(A)
40%	76 m ³ /h at 27 Pa	13 W	0.14 A	31.9 dB(A)	45 dB(A)	41 dB(A)
50%	97 m ³ /h at 44 Pa	18 W	0.20 A	34.7 dB(A)	43 dB(A)	43 dB(A)
60%	118 m ³ /h at 64 Pa	26 W	0.27 A	37.4 dB(A)	53 dB(A)	45 dB(A)
70%	141 m ³ /h at 92 Pa	37 W	0.37 A	40.2 dB(A)	57 dB(A)	48 dB(A)
80%	160 m ³ /h at 118 Pa	50 W	0.48 A	42.9 dB(A)	59 dB(A)	50 dB(A)
90%	178 m ³ /h at 147 Pa	66 W	0.61 A	44.7 dB(A)	62 dB(A)	52 dB(A)
100%	195 m ³ /h at 175 Pa	85 W	0.75 A	45.8 dB(A)	63 dB(A)	53 dB(A)

Default settings air volume

Absent Setting (nL / HL)	15%	15%
Low Setting (nL / HL)	35%	40%
Medium Setting (nL / HL)	50%	70%
High Setting (nL / HL)	70%	90%

Connection data

Power Supply	230V±10%, single phase, 50/60Hz	
cos φ ²	0.38 – 0.49	
Power Maximal	1250 W	5.77 A
Power Pre heater ³	250 W	4.99 A

General specifications

Material Housing	Coated Sheet Steel	
Material Interior	EPP and ABS	
Material Heat Exchanger	Polystyrene	
Material Enthalpy Exchanger	Polyethylene-polyether-copolymer	
Thermal Yield ²	up to 89%	
Weight	24kg	
Humidity Maximal	72% at 20°C	
Ambient temperature (minimum / maximum)	0°C	40°C
IP classification	IP40	
Filter class (outdoor air / return air)	G4 or F7	G4
Type speed control	4 speed	
Connecting air ducting	Sleeve	
Nominal diameter air ducting (top / bottom)	rectangular	125

Temperature sensors		10k NTC KTY 81-210		
Temperature	Resistance MIN.	Resistance MID.	Resistance MAX.	
10 °C	19,570 kΩ	19,904 kΩ	20,242 kΩ	
15 °C	15,485 kΩ	15,712 kΩ	15,941 kΩ	
18 °C	13,502 kΩ	13,681 kΩ	13,861 kΩ	
19 °C	12,906 kΩ	13,071 kΩ	13,237 kΩ	
20 °C	12,339 kΩ	12,491 kΩ	12,644 kΩ	
21 °C	11,801 kΩ	11,941 kΩ	12,082 kΩ	
22 °C	11,291 kΩ	11,420 kΩ	11,550 kΩ	
25 °C	9,900 kΩ	10,000 kΩ	10,100 kΩ	
30 °C	7,959 kΩ	8,057 kΩ	8,155 kΩ	

¹ The Lw noise power level is measured at 0m

² According to standard EN13141-7

³ At -15°C and 180m³/h

4.1 Configuration unit

Position	Part
A	External casing of coated sheetsteel
B	Interior of high-quality, expanded polypropylene EPP and ABS
C	5 connections for the air ducts
D	2 filters for air purification
E	2 energy-efficient DC motors with high-efficient fan
F	HE (High efficient) heat exchanger or enthalpy exchanger (standard in unit version "Enthalpie" and "ERV")
G	Display to read data, and for programming procedures (not present in the unit version "Luxe")
H	Electronics box with the Control PCB of the unit for all the standard connections
I	Identification plate detailing information on the unit (not visible)
J	Condensation drain to drain the condensation of the warm return air
K	Sticker detailing the air connections (not visible)
L	2 Service connectors for the ComfoSense or PC
	 The service connectors cannot be used at the same time
M	4 Filter caps
N	Pre heater (standard in unit version "V" and "PH")

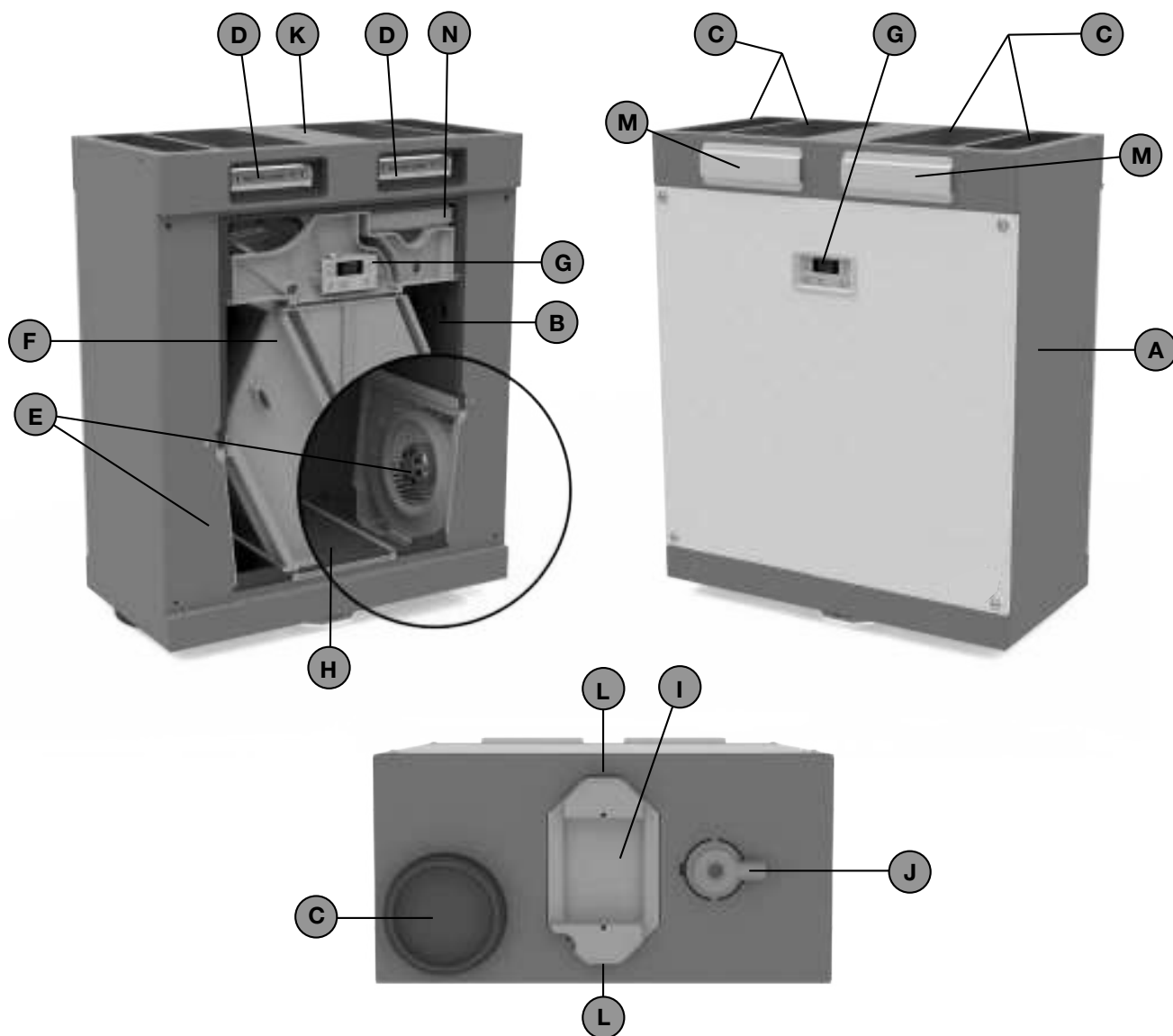

4.2 Dimension sketch

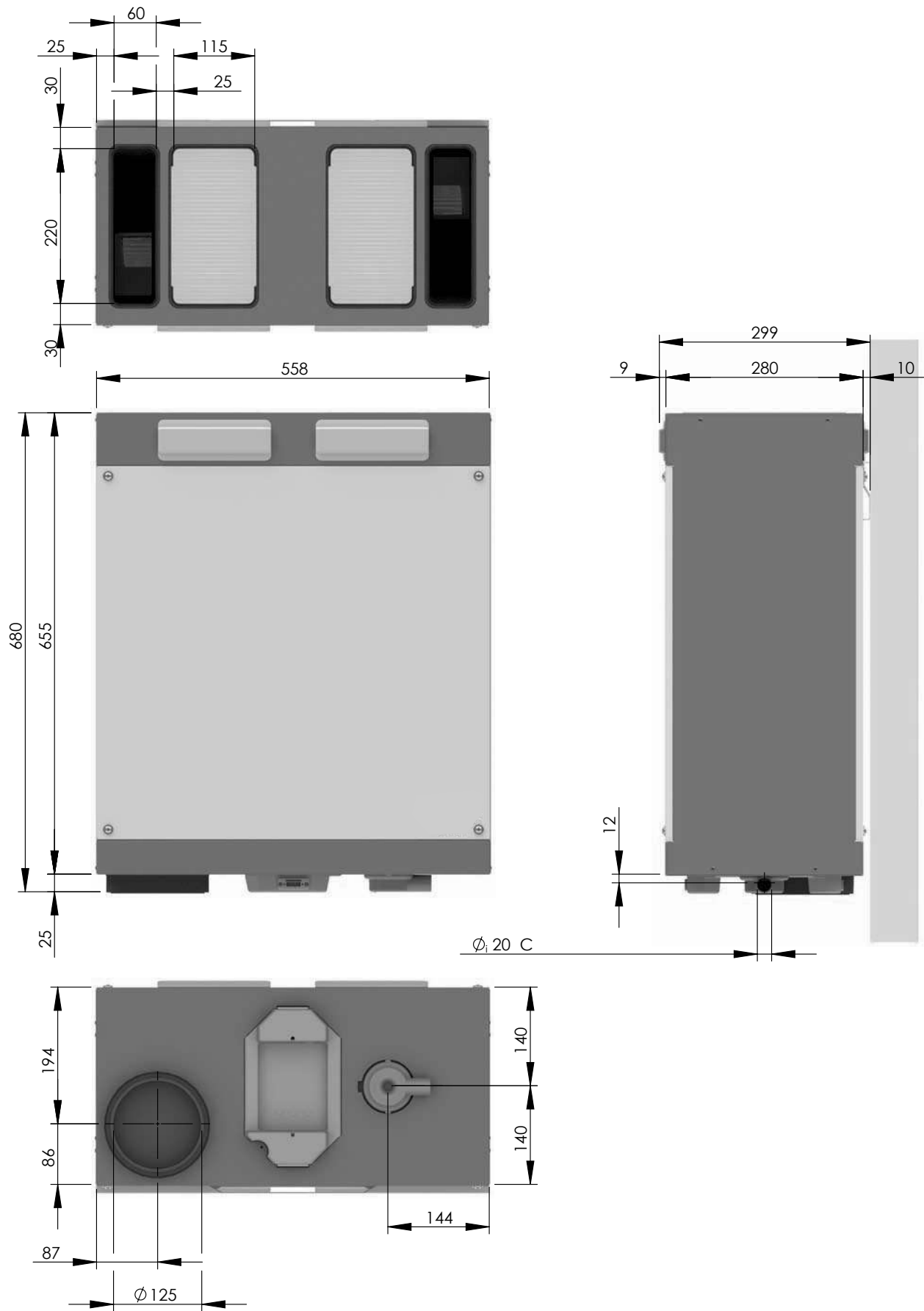

Legend

Code	Description
ODA	Outdoor air
SUP	Supply air
ETA	Extract air
EHA	Exhaust air
C	Condensation drain

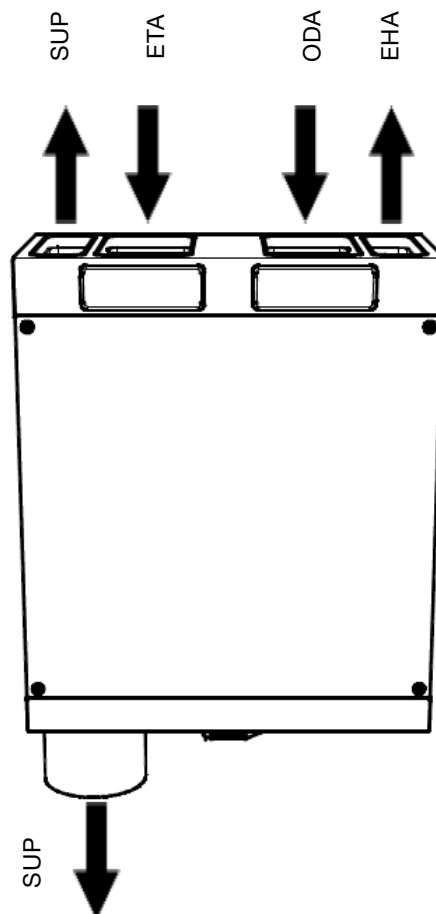
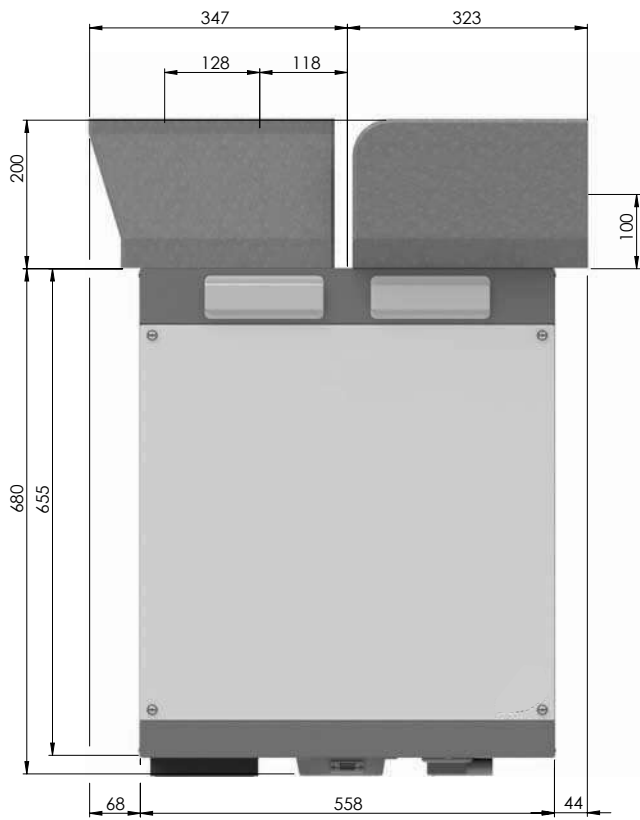
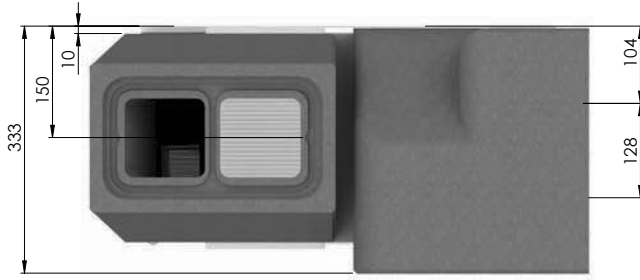

4.3 Wiring diagram

Legend Colour code

Code	Colour	Code	Colour	Code	Colour
(N) B	Blue	(L1) G	Grey	W	White
(PE) G/Y	Green/ Yellow	(L2) Bl	Black	Y	Yellow
		(L3) Br	Brown	R	Red

Legend

Code	Description	Code	Description
PH	Pre heater	T1	NTC-Sensor Outdoor air
M1	Exhaust motor	T2	NTC-Sensor Supply air
M2	Supply motor	T3	NTC-Sensor Return air
DISPLAY	Display	T4	NTC-Sensor Exhaust air
BYP	Bypass valve	BS	Bathroom controller
LED	n/a	SERV	Service/ComfoSense connector

Control PCB

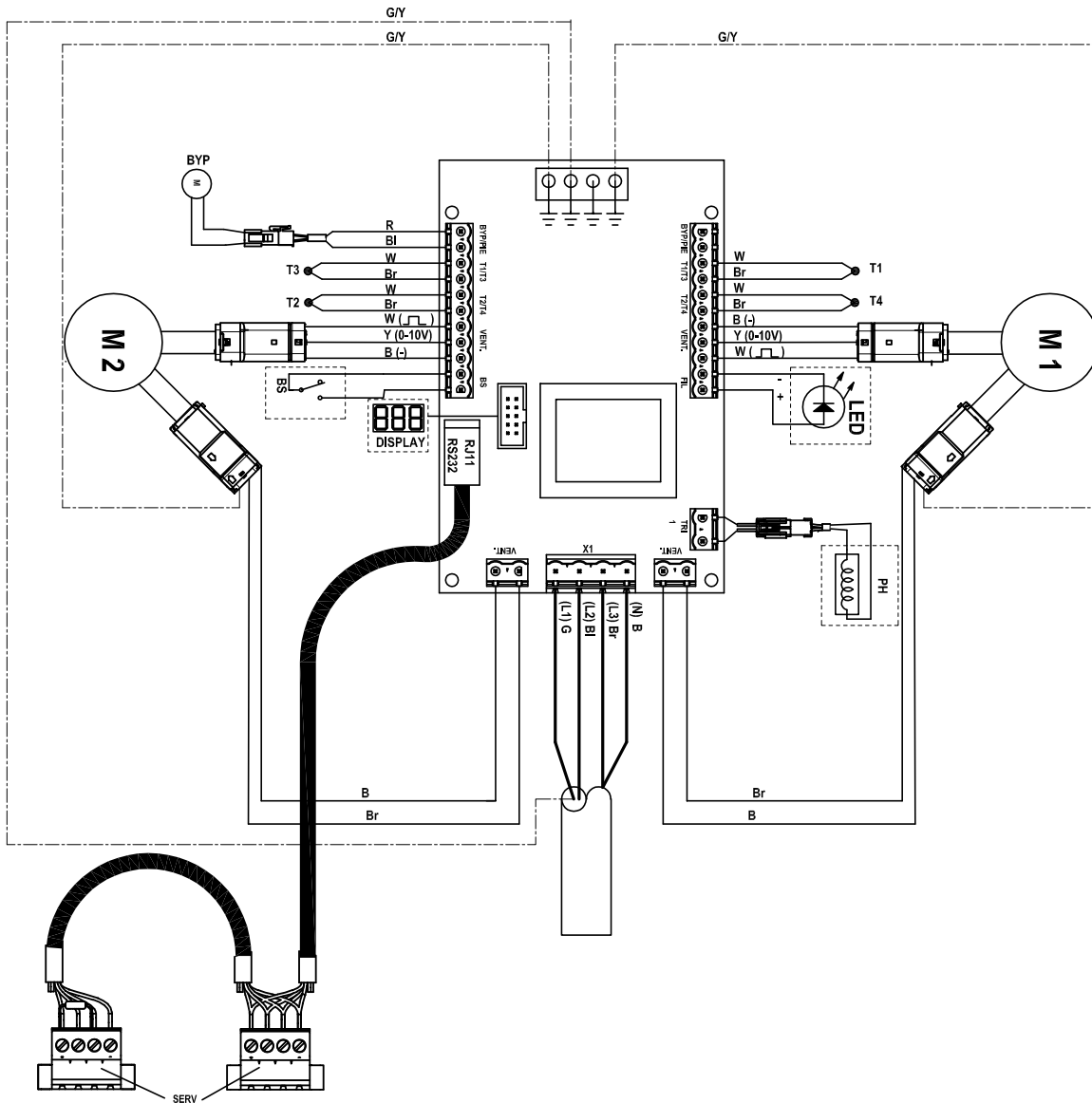

Power cord Luxe version

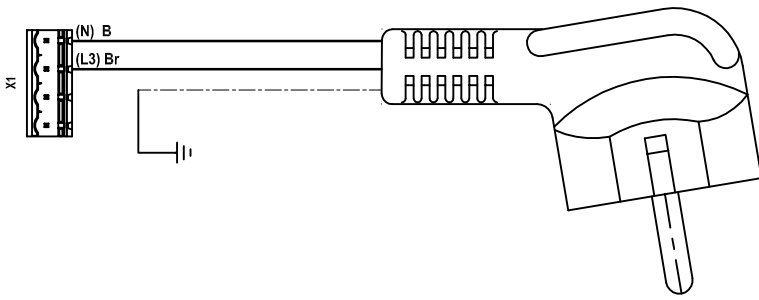

ComfoSense

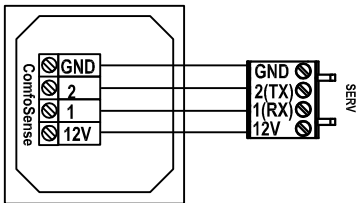

Position controller

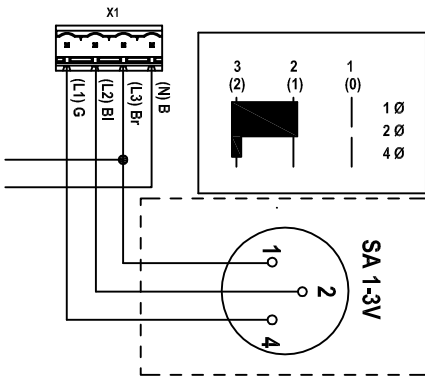





5 Installation



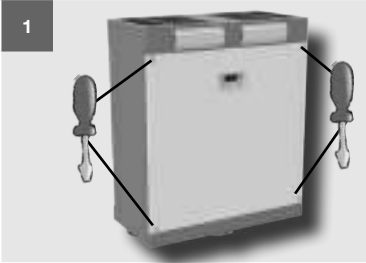
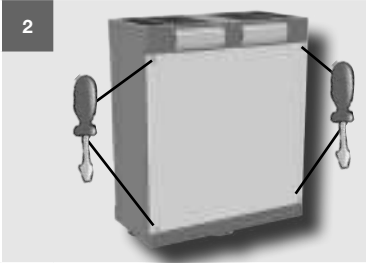
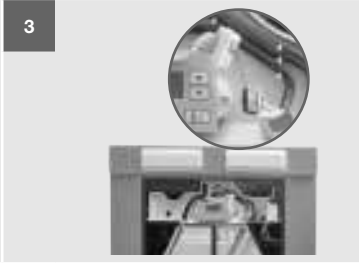
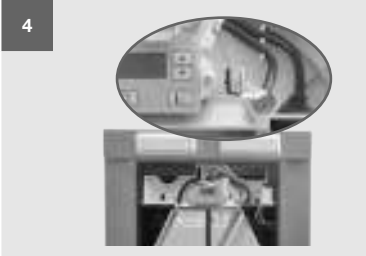
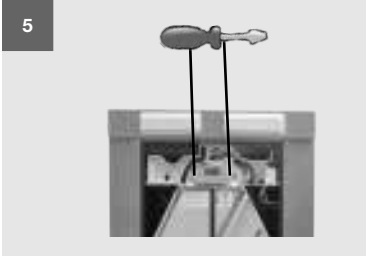
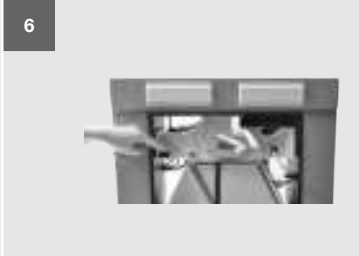



5.1 Rework Right to Left version

The unit version "Luxe" can be used as a Right-hand version or Left-hand version. Just mount the mounting bracket on the required side.

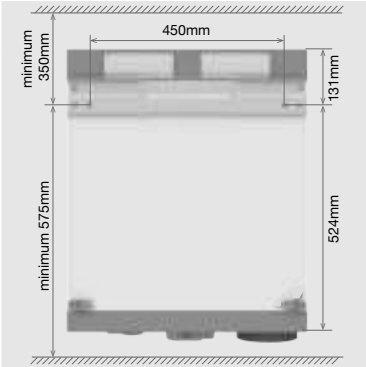
The unit with display is supplied as a Right-hand version (the supply and return side are on the right side of the unit). Follow the steps below when a Left-hand version is wanted:

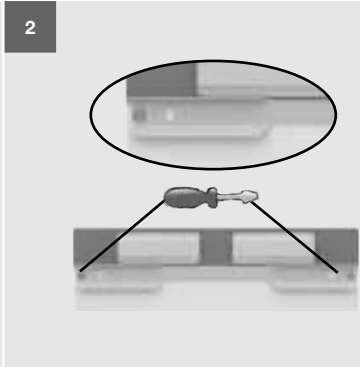
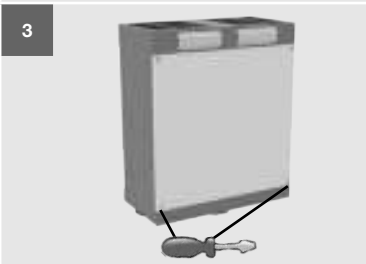
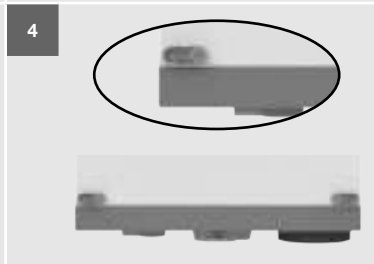
		
<p>Remove the front panel by unscrewing the 4 screws.</p>	<p>Release the back panel by unscrewing the 4 screws.</p>	<p>Remove the display connector.</p>
		
<p>Remove the grommet including the display cable.</p>	<p>Release the display by unscrewing the 2 screws.</p>	<p>Place the removed display on the back side of the unit. Remove the grommet on the back side of the unit. Place the removed grommet on the front side of the unit.</p>
		
<p>Run the display cable to the rear of the unit.</p> <p> Make sure the display cable is fixed between the holding pins in the middle of the frame.</p> <p>Slide the grommet on the display cable to the correct position and place the grommet into the opening.</p>	<p>Run the display cable between the holding pins next to the display. Connect the display connector again.</p>	<p>Place the removed display on the back side of the unit. Remove the grommet on the back side of the unit.</p>

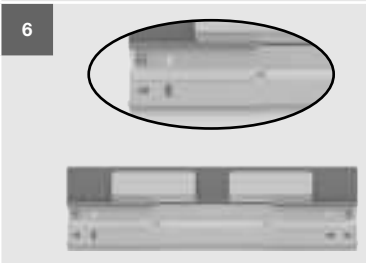
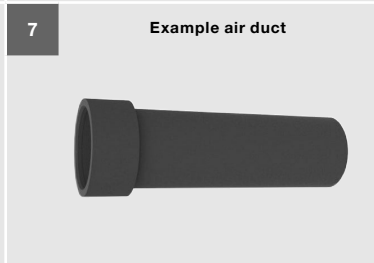
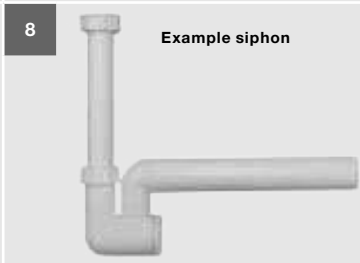
5.2 Wall mounting, standard

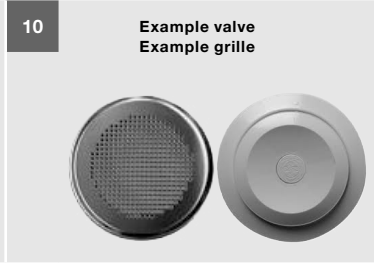
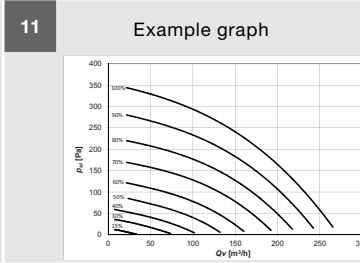
	<p>1</p> 	<p>2</p> 
<p>Mount the unit against a wall with a minimum mass of 200 kg/m².</p> <p>The stated height is an indication, and is dependent on the type of air ducts and condensation drain selected.</p>	<p>Remove the top 2 screws from the rear.</p> <p>If no display is fitted: Use the air-flow direction sticker on top of the unit to determine which side is the rear.</p>	<p>Use the screws removed to secure 1 of the mounting brackets supplied to the unit.</p> <ul style="list-style-type: none"> ■ Place the flat side of the mounting bracket against the unit; ■ Place the sloping side of the mounting bracket downwards;
<p>3</p> 	<p>4</p> 	<p>5</p> 
<p>Remove the bottom 2 screws from the rear.</p>	<p>Use the screws removed to secure 2 of the spacers supplied to the unit.</p>	<p>Mount the second mounting bracket supplied to the wall, ensuring it is level.</p> <ul style="list-style-type: none"> ■ Place the flat side of the mounting bracket against the wall; ■ Place the sloping side of the mounting bracket upwards;
<p>6</p> 	<p>7 Example air duct</p> 	<p>8 Example siphon</p> 
<p>Hang the unit on the mounting bracket fixed to the wall.</p>	<p>Fit the air ducts to the unit as described in the section on mounting air ducts.</p>	<p>Fit the siphon to the bottom of the unit as described in the section on mounting the condensation drain.</p>
<p>9 Example of controller(s)</p> 	<p>10 Example valve Example grille</p> 	<p>11 Example graph</p> 
<p>Connect the required controller(s) as described in the relevant controller manual.</p> <p>We recommend using the front-most connector for the ComfoSense.</p>	<p>Fit the valves and/or grilles as described in the section on mounting valves and/or grilles.</p>	<p>Programme the required air-flow volumes and time delays as described in the service manual.</p> <p>Fill in the installation report.</p>

5.3 Wall mounting, restricted height

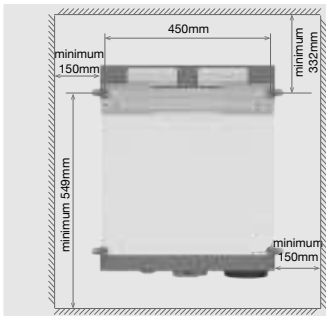

Mount the unit against a wall with a minimum mass of 200 kg/m².

The stated height is an indication, and is dependent on the type of air ducts and condensation drain selected.

1

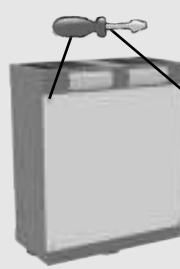

Remove the top 2 screws from the rear.

If no display is fitted:
Use the air-flow direction sticker on top of the unit to determine which side is the rear.

2

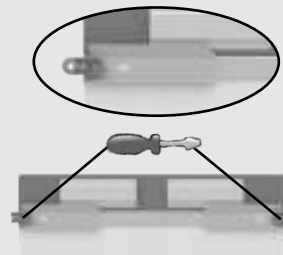

Use the screws removed to secure 1 of the mounting brackets supplied and 2 of the spacers supplied to the unit.

- Place the flat side of the mounting bracket against the unit;
- Place the sloping side of the mounting bracket upwards;

Allow the notches in the spacers to slot over the mounting bracket.

3

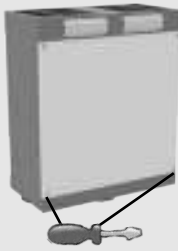

Remove the bottom 2 screws from the rear.

4

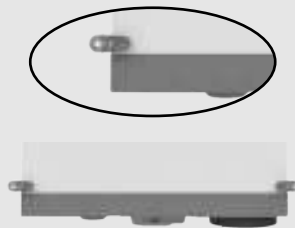

Use the screws removed to secure 2 of the spacers supplied to the unit.

5



Mount the second mounting bracket supplied to the wall, ensuring it is level.

- Place the flat side of the mounting bracket against the wall;
- Place the sloping side of the mounting bracket downwards;

6

Example of controllers(s)



Connect the required controller(s) as described in the relevant controller manual.



We recommend using the front-most connector for the ComfoSense.

7

Example air duct



Fit the air ducts to the unit as described in the section on mounting air ducts.

8

Example siphon



Fit the siphon to the bottom of the unit as described in the section on mounting the condensation drain.

9

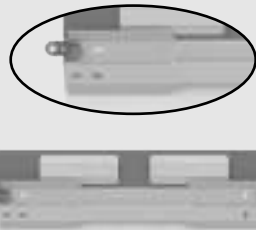

Hang the unit on the mounting bracket fixed to the wall.

Screw the 4 spacers to the wall.

10

**Example valve
Example grille**



Fit the valves and/or grilles as described in the section on mounting valves and/or grilles.

11

Example graph

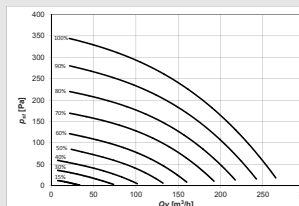

Programme the required air-flow volumes and time delays as described in the service manual.

Fill in the installation report.

5.4 Wall mounting, restricted height and width

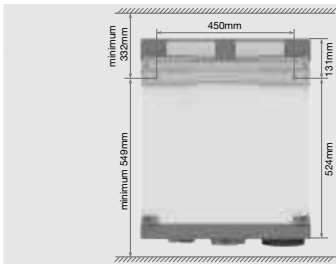

Mount the unit against a wall with a minimum mass of 200 kg/m². The sides should be stable enough to support the unit.

The stated height is an indication, and is dependent on the type of air ducts and condensation drain selected.

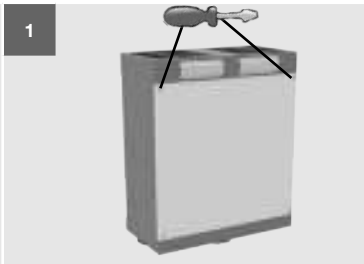

Remove the top 2 screws from the rear.

If no display is fitted:
Use the air-flow direction sticker on top of the unit to determine which side is the rear.

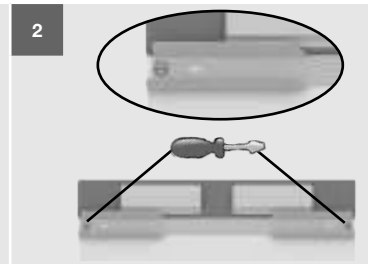

Use the screws removed to secure 1 of the mounting brackets supplied to the unit.

- Place the flat side of the mounting bracket against the unit;
- Place the sloping side of the mounting bracket upwards;

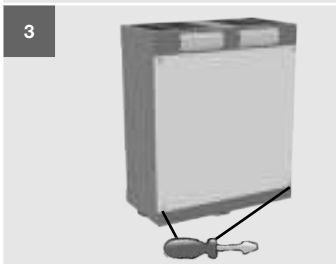

Remove the bottom 2 screws from the rear.



Use the screws removed to secure 2 of the spacers supplied to the unit.



Mount the second mounting bracket supplied to the wall, ensuring it is level.

- Place the flat side of the mounting bracket against the wall;
- Place the sloping side of the mounting bracket downwards;

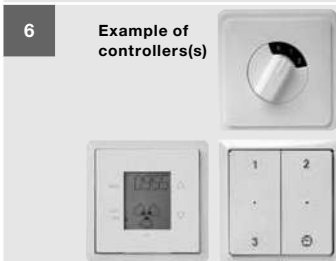

Connect the required controller(s) as described in the relevant controller manual.

We recommend using the front-most connector for the ComfoSense.



Fit the ComfoPipe Plus air ducts to the unit as described in the section on mounting air ducts.

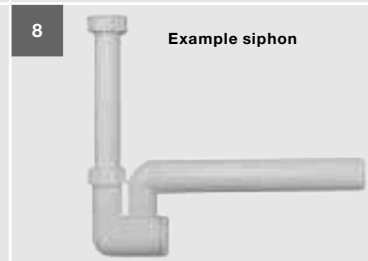

Fit the siphon to the bottom of the unit as described in the section on mounting the condensation drain.

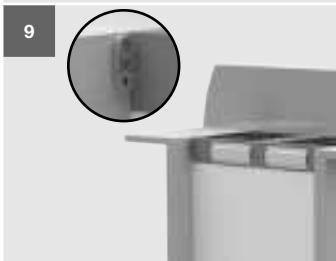

Hang/slide the unit onto the mounting bracket to the wall.

Press the side of the 4 spacers supplied against the 4 corners of the unit and screw them onto the side of the unit.

Ensure that the spacers do not block the removable front.



Fit the valves and/or grilles as described in the section on mounting valves and/or grilles.

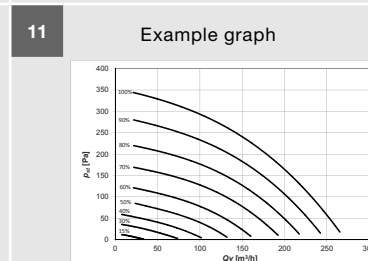

Programme the required air-flow volumes and time delays as described in the service manual.

Fill in the installation report.

5.5 Air ducts

Legend

Code	Description
ODA	Outdoor air
SUP	Supply air
ETA	Extract air
EHA	Exhaust air

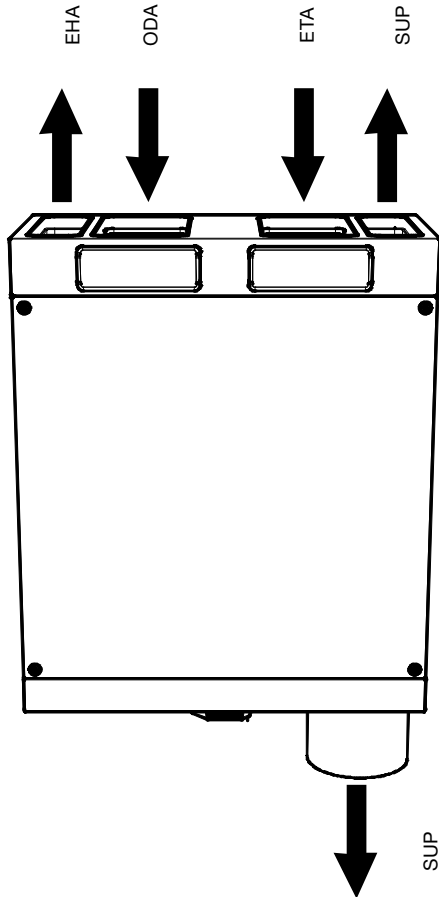

The following must be taken into account when fitting the air ducts:

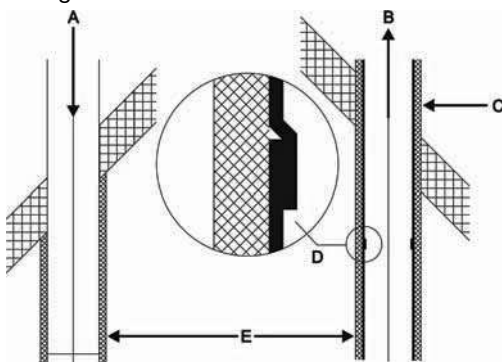

- The distance (E) between the opening of the supply duct (A) and the opening of the extraction duct (B) must be at least 1.5 m;
- The position of the supply opening (A) relative to other possible sources of stale air is very important (other exhaust-air outlets, street versus garden, etc.);
- The exhaust duct should drain (D) in the direction of the unit.

5.5.1 Top air ducts

The unit's top air duct openings can only be connected using a connector from the Zehnder ComfoPipe Plus air duct system. The following types of connector may be used:

- Right-handed connector;
- Left-handed connector;
- Vertical connector;

To fit the ComfoPipe Plus connector to the unit, refer to the instructions supplied with the connector.







5.5.2 Bottom supply air duct

At the bottom the unit is equipped with an optional Ø125mm supply air duct. The supply air fan needs to be rotated and the top supply air duct must be closed off when the bottom supply air duct is used. The top supply air duct can be closed off with a ComfoPipe Plus Wall feed-through set.

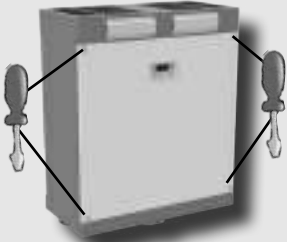
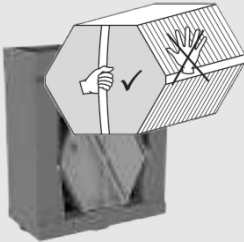
The following aspects must be taken into account, while installing the bottom air supply duct:

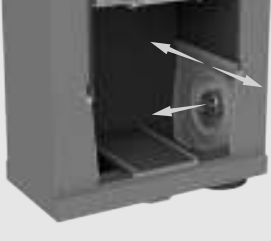
- To prevent unnecessary temperature loss in either the summer or the winter, we recommend fitting thermal and damp-proof insulation to the supply duct from the unit up to the supply valves;
- Install the air duct with a minimum \varnothing of 125mm, as little air resistance as possible and free from air leakage;
- Make sure the inside of the air ducts do not have an obstruction of any sort. Air ducts must not have sharp bends, dents or long screws inside. Obstructions will compromise the performance and maintenance of the system;
- Install a silencer of at least 1m straight directly onto the supply air connection. For relevant advice, please contact Zehnder;
- When using a flexible channel only Zehnder channel systems may be used. Any other flexible channel will disturb the basic operating principle of the balanced ventilation system.

Follow the steps below when the bottom supply air duct is used:

	<p>1</p> 	<p>2</p> 
<p>Seal the top supply air duct and remove the seal cap from the bottom opening (A).</p>	<p>Release the front panel by removing the 4 screws.</p>	<p>Pull on the strap to remove the heat exchanger, the bypass duct and the leakage tray.</p> <p> Do not cut the strap.</p>
<p>3</p> 	<p>4</p> 	<p>5</p> 
<p>Remove the sensor and its cabling from the supply-fan casing.</p>	<p>Press the 2 click connectors of the supply-fan casing outwards and pull the casing forwards.</p>	<p>Disconnect the fan cabling on the side and rear of the supply-fan casing.</p> <p>Guide the cabling through the clamps on the other side of the supply-fan casing.</p>
<p>6</p> 	<p>7</p> 	<p>8</p> 
<p>Remount the supply-fan casing upside-down (180°) in the 2 click connectors (E).</p>	<p>Refit the sensor to the supply-fan casing.</p> <p>Guide the sensor cabling through the second clamp on the supply-fan casing.</p>	<p>Refit the heat exchanger into the unit.</p> <p>Refit the front panel to the unit.</p>

5.6 Condensation drain

The condensation must be drained off frost-free, at a gradient and incorporate an air seal (U-bend or dry syphon). The connection for the condensation drain is located underneath the unit and has an external diameter of 20mm .

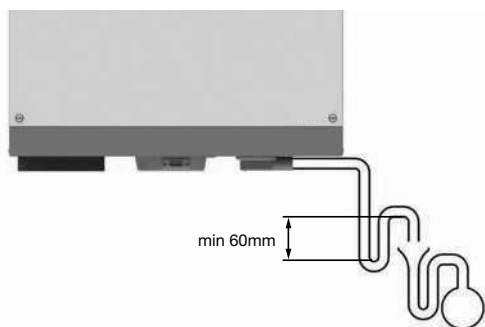

5.6.1 U-bend



! When an Enthalpy exchanger is present the unit may not be installed with a u-bend.

The following aspects must be taken into account, while installing the u-bend:

- Connect the condensation drain of the unit, via a pipe or hose, to a water seal (siphon);
- Position the upper edge of the water seal at least 60mm underneath the condensation drain of the unit;
- Make sure that the outer end of the pipe or tube exit is at least 60mm below the water level;
- The u-bend of the unit may not be connected directly to the domestic waste-water system. The u-bend of the unit must have a free outlet to the syphon of the domestic waste-water system.

5.6.2 Dry syphon



! When an Enthalpy exchanger is present the unit must be installed with a dry syphon.

The following aspects must be taken into account, while installing the dry syphon:

- Position the upper edge of the dry syphon ball at least 60mm underneath the condensation drain of the unit;
- The dry syphon of the unit may not be connected directly to the domestic waste-water system. The dry syphon of the unit must have a free outlet to the syphon of the domestic waste-water system.

5.7 Valves and/or grilles



Example grille

Example valve

The following aspects must be taken into account, while installing valves and/or grilles:

- Install the valves and/or grilles at least 1m from each other;
- To increase the comfort for the user use clean sector valves when the valves are installed close to the wall;
- We recommend that the ventilation system is fitted with supply and extract valves made by Zehnder;
- A gap or grate should be left near the doors in order to ensure effective and draught free airflow in the house. The gap or grate must provide an overflow of at least 12 cm² per l/s (a gap under the inside doors must be at least 7600mm² above the floor finish).

! If these openings are obstructed, due to furniture, draught excluders or deep pile carpet, the airflow in the house will stagnate. As a result, system performance will be compromised or fail altogether.

5.8 Extractor hood (optional)



Example extractor hood

It is possible to fit the ventilation system with a non-powered extractor hood. The extractor hood is part of the ducting of the ventilation system, and does not form part of the unit. The unit can therefore not turn a non-powered extractor hood on and off. We recommend that the ventilation system is fitted with a non-powered extractor hood made by Zehnder.

! A powered extractor hood may never be connected to the same ducting as the unit.

To protect the heat exchanger from the dirt removed with the non-powered extractor hood the ducting between the non-powered extractor hood and unit must be at least 3m.

5.9 External filter (optional)



Example external filter

It is possible to fit the ventilation system with an external filter, for instance the FilterBox from Zehnder. The external filter is part of the ducting of the ventilation system, and does not form part of the unit. The unit can therefore not provide an filter error for the external filter.

5.10 Unregulated sub-soil heat exchanger (optional)



Example unregulated sub-soil heat exchanger inlet

It is possible to fit the ventilation system with an unregulated sub-soil heat exchanger. The sub-soil heat exchanger is part of the ducting of the ventilation system, and does not form part of the unit. It is therefore not possible to control a sub-soil heat exchanger from the unit.



Quick Installation Guide

Please refer to the full installation manual for detailed installation and commissioning information.

Legend

Code	Colour
ODA	Outside air
SUP	Supply air
ETA	Return air
EHA	Exhaust air
N	Blue
L1	Grey
L2	Black
L3	Brown
SERV	Service/ComfoSense connector

