

## ShieldGLAND Elite M20S

ShieldGLAND Elite M20S COMBI 308, E-Spring, earth fly lead

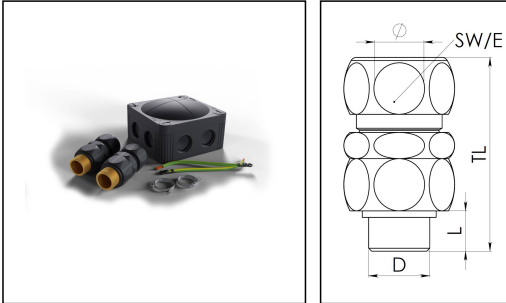

Products may differ in size, colour and appearance to those shown. If you require further information or customisation, please contact us directly.

<b>Material sealing gasket</b>	TPE
<b>Temp. range min</b>	-40 °C
<b>Temp. range max</b>	120 °C
<b>Protection class</b>	IP68 (5 bar 30 min)
<b>Thread type</b>	M
<b>Ø Connection thread D</b>	20
<b>Lead</b>	1,5
<b>Length screw-in thread L</b>	11 mm
<b>Ø cable diameter min</b>	7 mm
<b>Ø cable diameter max</b>	16 mm
<b>Ø cable below cable shield max</b>	7 mm - 11 mm
<b>Key width SW</b>	27 mm
<b>Collar diameter (E)</b>	30 mm
<b>Total length TL</b>	57 mm - 63 mm
<b>Type</b>	ShieldGLAND Elite M20S
<b>WISKA-Order no.</b>	10112398
<b>Packing unit</b>	1

Remarks:

Complete with E-Spring, earth fly lead  
and Junction box COMBI 308 black

16.10.2023

Your Contact:

**WISKA UK Ltd.**

Unit 7, Hurling Way · St. Columb Major Business Park · TR9 6SX, St. Columb Major, Cornwall · Great Britain

☎ +44-12-08816062 · 📠 +44-12-08816708

info@wiska.co.uk · www.wiska.co.uk

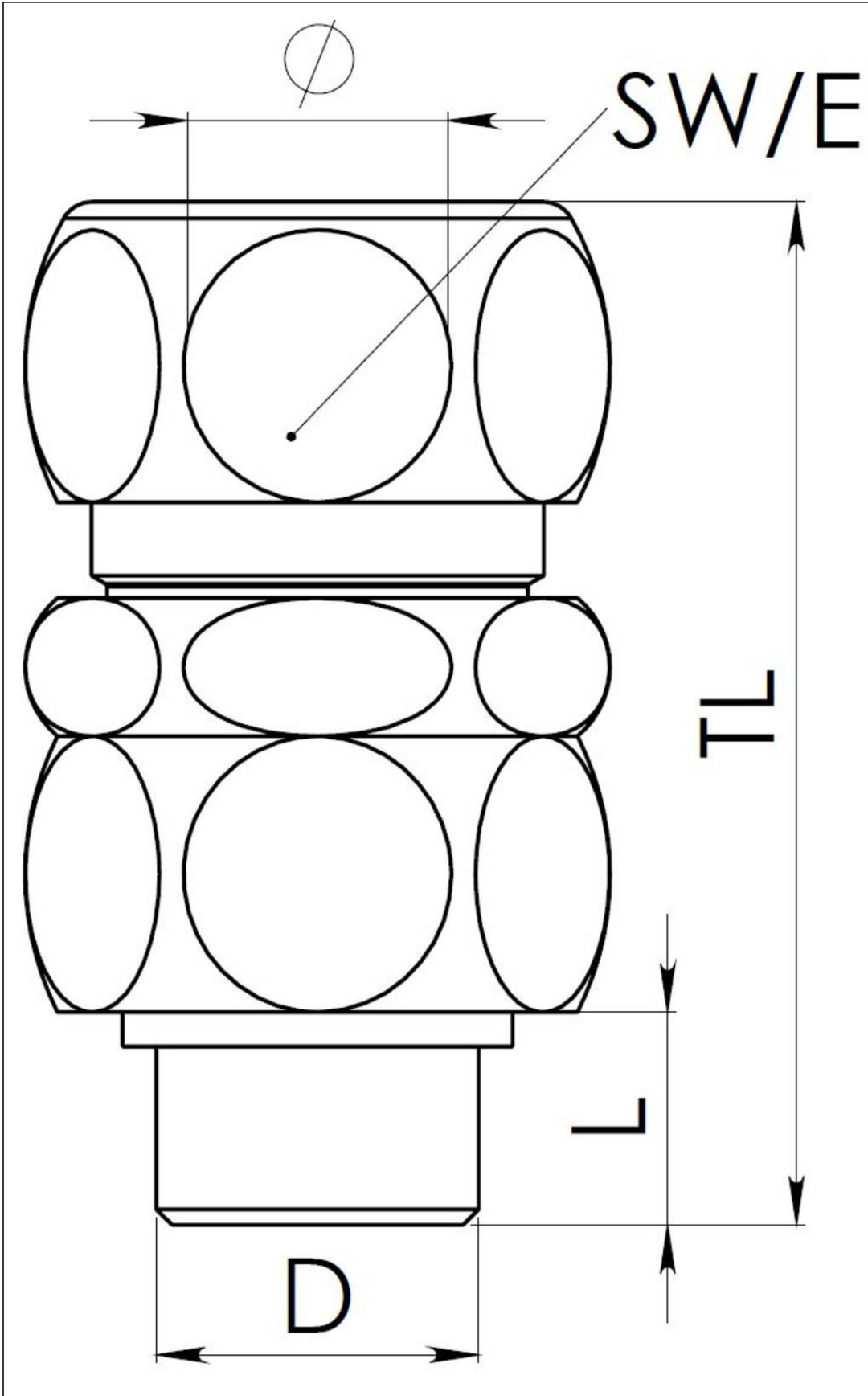

Your Contact:

**WISKA UK Ltd.**

Unit 7, Hurling Way · St. Columb Major Business Park · TR9 6SX, St. Columb Major, Cornwall · Great Britain

☎ +44-12-08816062 · 📠 +44-12-08816708

info@wiska.co.uk · www.wiska.co.uk