

EMSVG 63

Pressure compensation cable gland, brass nickel-plated, M63

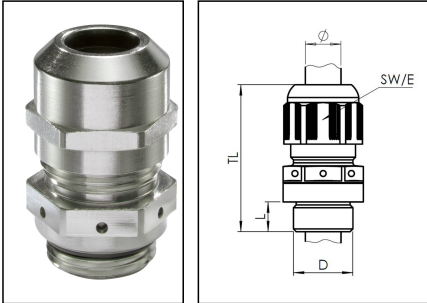

Products may differ in size, colour and appearance to those shown. If you require further information or customisation, please contact us directly.



Material cable gland	Brass nickel-plated
Material membrane	ePTFE
Material sealing gasket	EPDM
Airflow at 70mbar	285 l/h
Temp. range min	-40 °C
Temp. range max	100 °C
Protection class	IP68 / IP69
Thread type	M
Ø Connection thread D	63
Lead	1,5
Length screw-in thread L	10 mm
Ø cable diameter min	34 mm
Ø cable diameter max	48 mm
Key width SW	68 mm
Collar diameter (E)	75 mm
Install. torques fitting	40 N m
Install. torques cap nut	40 N m
Total length TL	69 mm - 83 mm
Order no. nickel-plated	10065905
Type	EMSVG 63
Packing unit	1
EAN number	4007685659055
Tariff number	74198090
ETIM-Classification	EC000441

Your Contact:

WISKA Hoppmann GmbH

Kisdorfer Weg 28 · 24568 Kaltenkirchen · Germany

☎ +49-4191-508-0 · 📠 +49-4191-508-209

contact@wiska.de · www.wiska.com

Recommended accessories

RDE 63	10062189
EMMU 63	10063148
BS 48	10064019
MFD 63/01/131-01/118-03/084-02/064	10101114
MFD 63/03/065	10101201
MFD 63/02/065-01/090	10101223

23.10.2023

Your Contact:

WISKA Hoppmann GmbH

Kisdorfer Weg 28 · 24568 Kaltenkirchen · Germany

 +49-4191-508-0 ·  +49-4191-508-209

contact@wiska.de · www.wiska.com

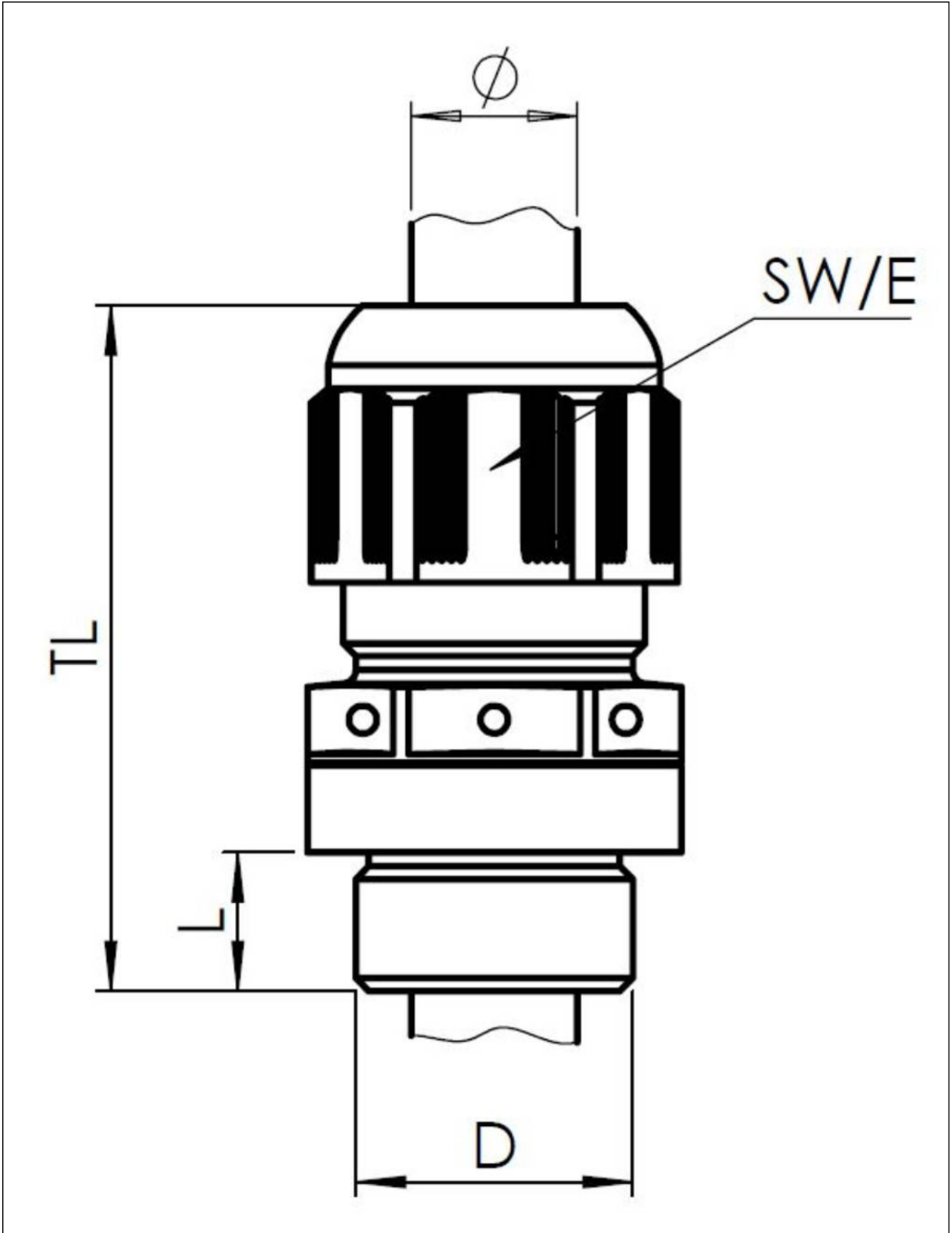

Your Contact:
WISKA Hoppmann GmbH
Kisdorfer Weg 28 · 24568 Kaltenkirchen · Germany
☎ +49-4191-508-0 · 📠 +49-4191-508-209
contact@wiska.de · www.wiska.com