

EMSKVZ-L 63

Cable gland long, brass nickel-plated, M63, with external strain relief

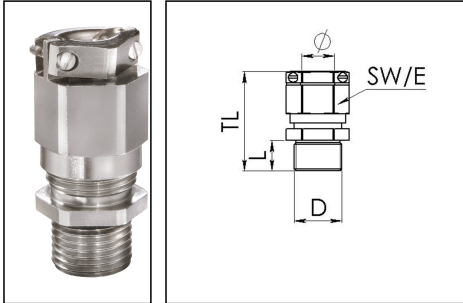

Products may differ in size, colour and appearance to those shown. If you require further information or customisation, please contact us directly.



Material cable gland	Brass nickel-plated
Material clamping cage	Polyamide
Material sealing gasket	EPDM
Temp. range min	-40 °C
Temp. range max	100 °C
Protection class	IP69, IP68 (5 bar 30 min)
Thread type	M
Ø Connection thread D	63
Lead	1,5
Length screw-in thread L	15 mm
Ø cable diameter min	34 mm
Ø cable diameter max	48 mm
Key width SW	68 mm
Collar diameter (E)	75 mm
Total length TL	78 mm - 89 mm
Type of cable anchorage	B
Install. torques fitting	40 N m
Install. torques cap nut	40 N m
Impact category	6
Torque clamp srew	0,6 N m
Surface	Nickel-plated
Order no. nickel-plated	10065866
Packing unit	5
Type	EMSKVZ-L 63
Tariff number	74198090

Your Contact:

WISKA Hoppmann GmbH

Kisdorfer Weg 28 · 24568 Kaltenkirchen · Germany

☎ +49-4191-508-0 · 📠 +49-4191-508-209

contact@wiska.de · www.wiska.com

EAN number	4007685658669
ETIM-Classification	EC000441

Recommended accessories

RDE 63	10062189
EMMU 63	10063148
BS 48	10064019

23.10.2023

Your Contact:

WISKA Hoppmann GmbH

Kisdorfer Weg 28 · 24568 Kaltenkirchen · Germany

☎ +49-4191-508-0 · 📠 +49-4191-508-209

contact@wiska.de · www.wiska.com

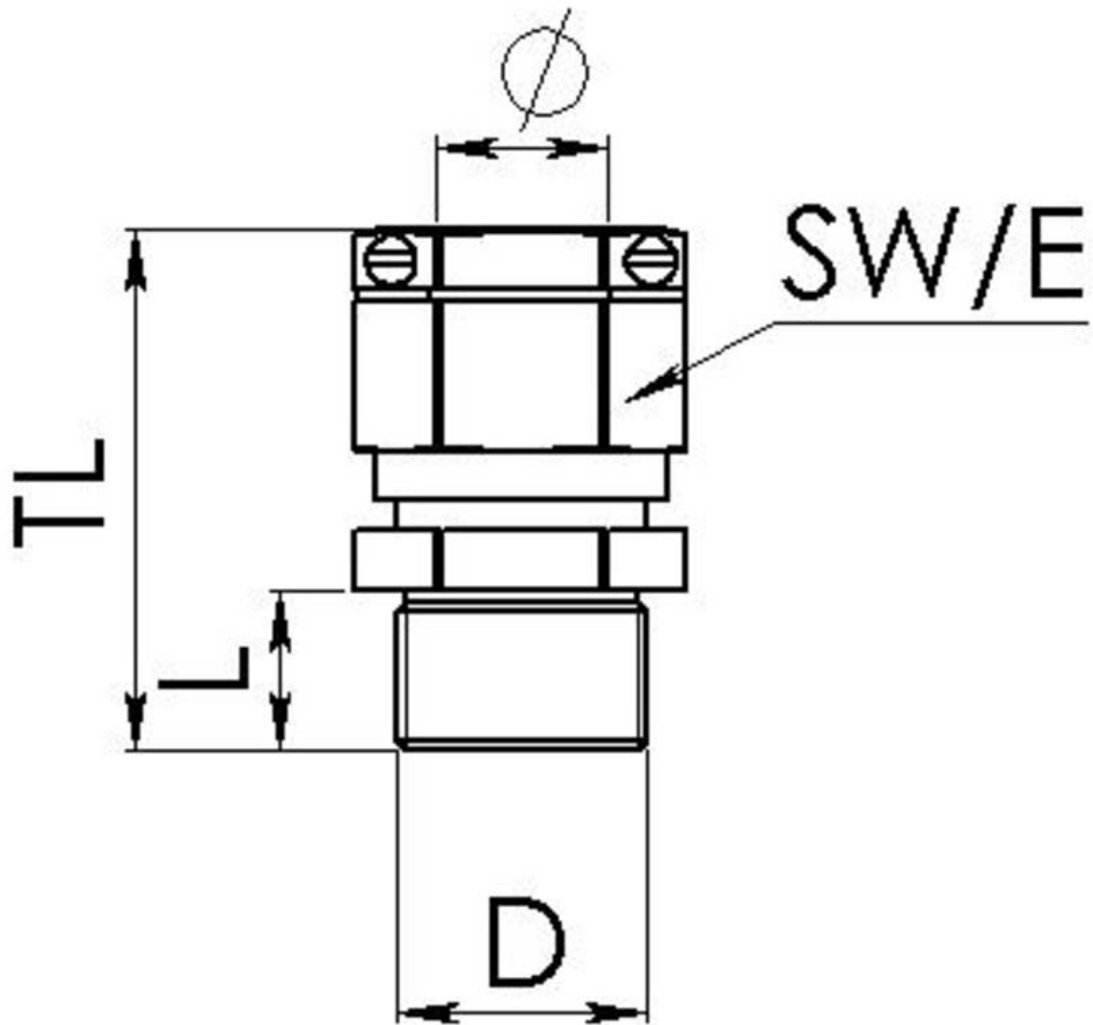

Your Contact:
WISKA Hoppmann GmbH
Kisdorfer Weg 28 · 24568 Kaltenkirchen · Germany
☎ +49-4191-508-0 · 📠 +49-4191-508-209
contact@wiska.de · www.wiska.com