

EMSKV-L 20 EMV-S

EMC-cable gland, brass nickel-plated with long thread, M20

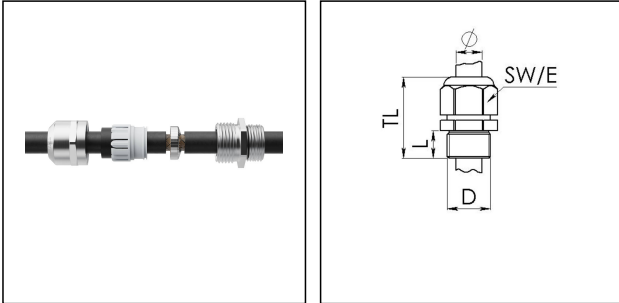

Products may differ in size, colour and appearance to those shown. If you require further information or customisation, please contact us directly.



Material cable gland	Brass nickel-plated
Material sealing gasket	EPDM
Material clamping cage	Polyamide
Material earthing insert	Stainless steel 1.4310
Temp. range min	-40 °C
Temp. range max	100 °C
Protection class	IP68 (5 bar 30 min), IP69
Thread type	M
Ø Connection thread D	20
Lead	1,5
Length screw-in thread L	12 mm
Ø cable diameter min	6 mm
Ø cable diameter max	13 mm
Cable Ø shield external	5 mm - 12 mm
Key width SW	24 mm
Collar diameter (E)	27 mm
Total length TL	35 mm - 43 mm
Type of cable anchorage	A
Install. torques cap nut	8 N m
Install. torques fitting	8 N m
Impact category	6
Surface	Nickel-plated
WISKA-Order no.	10102647
Type	EMSKV-L 20 EMV-S
Packing unit	50

Your Contact:

WISKA Hoppmann GmbH

Kisdorfer Weg 28 · 24568 Kaltenkirchen · Germany

☎ +49-4191-508-0 · 📠 +49-4191-508-209

contact@wiska.de · www.wiska.com

Tariff number	74198090
EAN number	4007685063029

Recommended accessories

RDE 20	10062185
EMMU-EMV 20	10063212
BS 13	10064010

20.10.2023

Your Contact:

WISKA Hoppmann GmbH

Kisdorfer Weg 28 · 24568 Kaltenkirchen · Germany

☎ +49-4191-508-0 · 📠 +49-4191-508-209

contact@wiska.de · www.wiska.com



Your Contact:

WISKA Hoppmann GmbH

Kisdorfer Weg 28 · 24568 Kaltenkirchen · Germany

☎ +49-4191-508-0 · 📠 +49-4191-508-209

contact@wiska.de · www.wiska.com