

EMSKV 75

Cable gland, brass with short thread

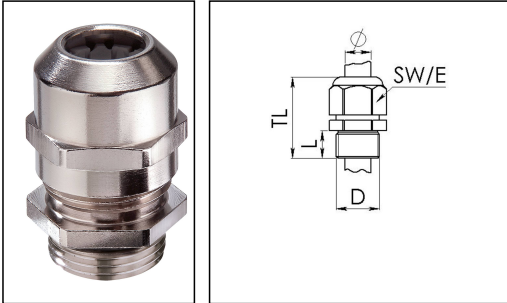

Products may differ in size, colour and appearance to those shown. If you require further information or customisation, please contact us directly.



Material cable gland	Brass nickel-plated
Material clamping cage	Polyamide
Material sealing gasket	EPDM
Temp. range min	-40 °C
Temp. range max	100 °C
Protection class	IP68 (5 bar 30 min), IP69
Thread type	M
Ø Connection thread D	75
Lead	1,5
Length screw-in thread L	12 mm
Ø cable diameter min	48 mm
Ø cable diameter max	62 mm
Key width SW	82 mm
Collar diameter (E)	90 mm
Total length TL	67 mm - 81 mm
Type of cable anchorage	A
Install. torques fitting	40 N/m
Install. torques cap nut	40 N/m
Impact category	6
Surface	Nickel-plated
Order no. nickel-plated	10100865
Type	EMSKV 75
Packing unit	1
Tariff number	74198090
EAN number	4007686069495

Your Contact:

WISKA UK Ltd.

Unit 7, Hurling Way · St. Columb Major Business Park · TR9 6SX, St. Columb Major, Cornwall · Great Britain

☎ +44-12-08816062 · 📠 +44-12-08816708

info@wiska.co.uk · www.wiska.co.uk

ETIM-Classification

EC000441

Recommended accessories



BS 63	10064020
EMMU 75	10101777

19.10.2023

Your Contact:

WISKA UK Ltd.

Unit 7, Hurling Way · St. Columb Major Business Park · TR9 6SX, St. Columb Major, Cornwall · Great Britain

 +44-12-08816062 ·  +44-12-08816708

info@wiska.co.uk · www.wiska.co.uk



Your Contact:

WISKA UK Ltd.

Unit 7, Hurling Way · St. Columb Major Business Park · TR9 6SX, St. Columb Major, Cornwall · Great Britain

☎ +44-12-08816062 · 📠 +44-12-08816708

info@wiska.co.uk · www.wiska.co.uk