

EMSKV 40 EMV-S

EMC-cable gland, brass nickel-plated with short thread, M40

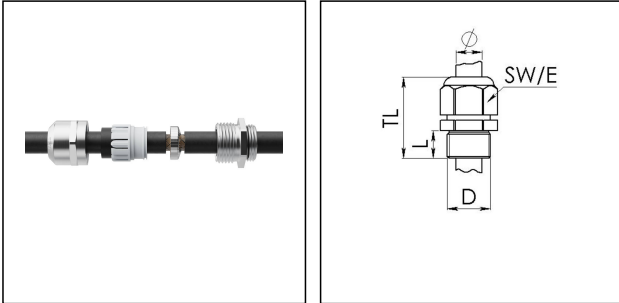

Products may differ in size, colour and appearance to those shown. If you require further information or customisation, please contact us directly.



Material cable gland	Brass nickel-plated
Material sealing gasket	EPDM
Material clamping cage	Polyamide
Material earthing insert	Stainless steel 1.4310
Temp. range min	-40 °C
Temp. range max	100 °C
Protection class	IP68 (5 bar 30 min), IP69
Thread type	M
Ø Connection thread D	40
Lead	1,5
Length screw-in thread L	8 mm
Ø cable diameter min	16 mm
Ø cable diameter max	28 mm
Cable Ø shield external	14 mm - 26 mm
Key width SW	46 mm
Collar diameter (E)	51 mm
Total length TL	44 mm - 55 mm
Type of cable anchorage	A
Install. torques cap nut	20 N m
Install. torques fitting	20 N m
Impact category	6
Surface	Nickel-plated
Order no. nickel-plated	10102278
Type	EMSKV 40 EMV-S
Packing unit	10

Your Contact:

WISKA Hoppmann GmbH

Kisdorfer Weg 28 · 24568 Kaltenkirchen · Germany

☎ +49-4191-508-0 · 📠 +49-4191-508-209

contact@wiska.de · www.wiska.com

Tariff number	85369010
EAN number	4007685046466
ETIM-Classification	EC000441

Recommended accessories

RDE 40	10062187
EMMU-EMV 40	10063215
BS 28	10064016

20.10.2023

Your Contact:

WISKA Hoppmann GmbH

Kisdorfer Weg 28 · 24568 Kaltenkirchen · Germany

☎ +49-4191-508-0 · 📠 +49-4191-508-209

contact@wiska.de · www.wiska.com



Your Contact:

WISKA Hoppmann GmbH

Kisdorfer Weg 28 · 24568 Kaltenkirchen · Germany

☎ +49-4191-508-0 · 📠 +49-4191-508-209

contact@wiska.de · www.wiska.com