

EMSKV 12 EMV-S

EMC-cable gland, brass nickel-plated with short thread, M12

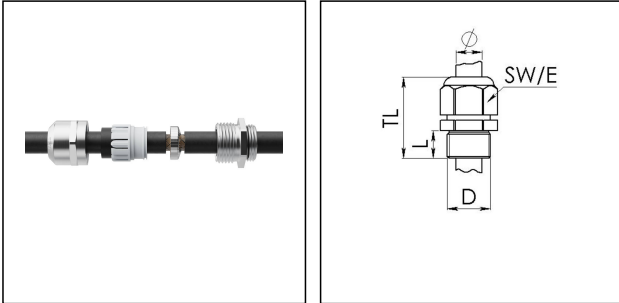

Products may differ in size, colour and appearance to those shown. If you require further information or customisation, please contact us directly.



Material cable gland	Brass nickel-plated
Material sealing gasket	EPDM
Material clamping cage	Polyamide
Material earthing insert	Stainless steel 1.4310
Temp. range min	-40 °C
Temp. range max	100 °C
Protection class	IP69, IP68 (5 bar 30 min)
Thread type	M
Ø Connection thread D	12
Lead	1,5
Length screw-in thread L	5 mm
Ø cable diameter min	3 mm
Ø cable diameter max	7 mm
Cable Ø shield external	2 mm - 6 mm
Key width SW	16 mm
Collar diameter (E)	18 mm
Total length TL	23 mm - 30 mm
Type of cable anchorage	A
Install. torques cap nut	4 N m
Install. torques fitting	4 N m
Impact category	6
Surface	Nickel-plated
Order no. nickel-plated	10102273
Type	EMSKV 12 EMV-S
Packing unit	50

Your Contact:

WISKA Hoppmann GmbH

Kisdorfer Weg 28 · 24568 Kaltenkirchen · Germany

☎ +49-4191-508-0 · 📠 +49-4191-508-209

contact@wiska.de · www.wiska.com

Tariff number	85369010
EAN number	4007685046411
ETIM-Classification	EC000441

Recommended accessories

RDE 12	10062183
EMMU-EMV 12	10063210
BS 7	10064005

20.10.2023

Your Contact:

WISKA Hoppmann GmbH

Kisdorfer Weg 28 · 24568 Kaltenkirchen · Germany

☎ +49-4191-508-0 · 📠 +49-4191-508-209

contact@wiska.de · www.wiska.com



Your Contact:

WISKA Hoppmann GmbH

Kisdorfer Weg 28 · 24568 Kaltenkirchen · Germany

☎ +49-4191-508-0 · 📠 +49-4191-508-209

contact@wiska.de · www.wiska.com