

S V A R A

Stylish and versatile bathroom fan



Instruction Manual

A product by
Vent-Axia

CE UK
CA

Contents

Important Information	2	Accessories	12
Installation and Wiring Instructions	3-11	Pin Code	12

Important: READ THESE INSTRUCTIONS BEFORE COMMENCING THE INSTALLATION

DO NOT install this product in areas where the following may be present or occur:

- Excessive oil or a grease laden atmosphere.
- Corrosive or flammable gases, liquids or vapours.
- Ambient temperatures are outside 5-50°C.
- Possible obstructions which would hinder the access or removal of the Fan.

SAFETY AND GUIDANCE NOTES

- A. All wiring to be in accordance with the current I.E.E. Regulations, or the appropriate standards of your country and **MUST** be installed by a suitably qualified person.
- B. The Fan should be provided with a local isolator switch capable of disconnecting all poles, having a contact separation of at least 3mm.
- C. Ensure that the mains supply (Voltage, Frequency, and Phase) complies with the rating label.
- D. The Fan should only be used in conjunction with the appropriate Vent-Axia products.
- E. The fan should only be used in conjunction with fixed wiring.
- F. When the Fan is used to remove air from a room containing a fuel-burning appliance, ensure that the air replacement is adequate for both the fan and the fuel-burning appliance.
- G. The Fan should not be used where it is liable to be subject to direct water spray for prolonged periods of time.
- H. Where ducted Fans are used to handle moisture-laden air, a condensation trap should be fitted. Horizontal ducts should be arranged to slope slightly downwards away from the Fan.
- I. This appliance is not intended for use by young children or infirm persons without supervision.
- J. Young children should be supervised to ensure that they do not play with the appliance.
- K. The exterior grille should be at least 2.3m above the ground to prevent people from being able to access moving parts. If the external grille is positioned between 0.2-2.3m from the ground, please use the Vent-Axia wall kit to ensure people cannot access the fans impeller from the outside.

Installation

Installation Preparation

- Loosen the motor unit by grasping it as shown in Figure (A), prise off the motor unit by leveraging against the cap with your knuckles. Ensure that you have the motor unit in a secure grip so you do not drop it when it loosens.
- Then loosen the wall frame by using a screw-driver pressing the lock button as shown in Figure (B) then remove the cover from the wall frame according to figure (C).

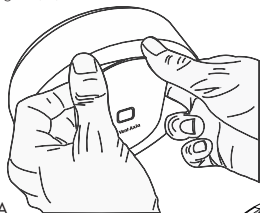

A.

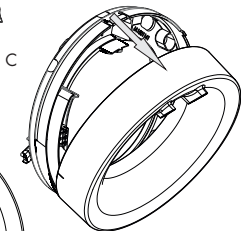

C.

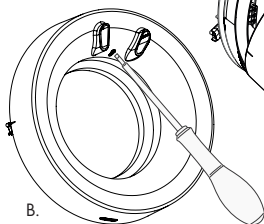

B.

- Fit the enclosed wall gasket as shown in the figure (C_1).

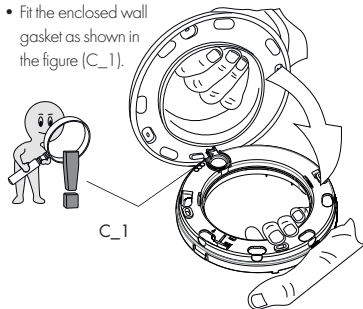

C_1

New Installations

- New installations require holes using a $\varnothing 110$ mm hole saw (Figure D).

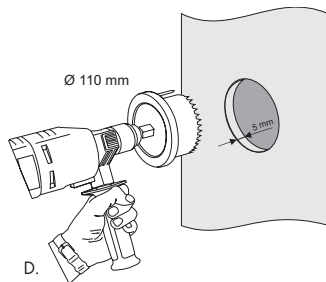

D.

- Vent-Axia wall kits and external grilles are available as accessories. (Figure E).

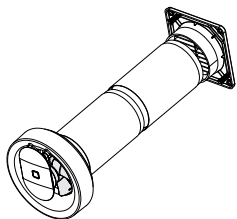

E.

The fan's wall seal has a short spigot which fits inside the $\varnothing 100$ mm pipe. Make sure when mounting to adapt the length of the wall pipe so it does not push back the wall seal so the fan impeller cannot rotate. Always customise a wall pipe, existing or new, so it ends about 5 mm inside the wall surface where the fan is to be installed. The wall frame with its seal is prepared with 5 cable entry points (Figure F) for concealed electrical connection or surface-mounted cable using the dimension shown in Figure G.

- Make sure that the gasket is properly installed on the wall frame, place it in the appropriate place and centre it in the pipe. The wall frame can be offset horizontally by placing a spirit level on its support points (Figure H and I).

- Use ageing-resistant sealant to seal around cables that are laid through the wall seal.

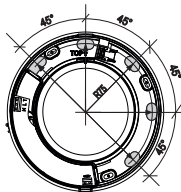

F.

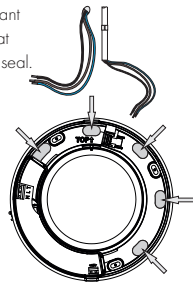

G.

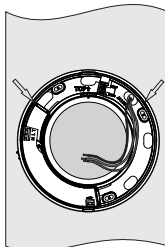

H.

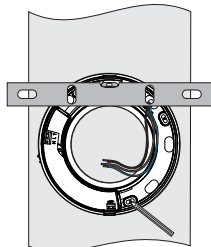

I.

- Mark the three attachment points for the appropriate screws to the substrate (Figure J).
Tighten the screws so that gasket seals against the wall.

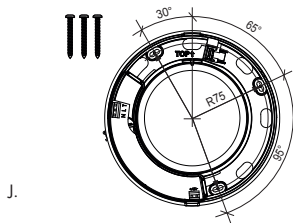

Always use a qualified electrician

All electrical connections 100-240V must be performed by a qualified electrician. Any electrical work on the product must utilize a voltage break.

Electrical connection can be made according to the wiring diagram on page 8-9 and the fan is suitable for connection to either 100-240VAC or 12VDC.

NOTE: The internal cable route must be as indicated as figures K/K1 (240VAC) and L (12VDC) to prevent the cable blocking the locator's for the motor assembly.

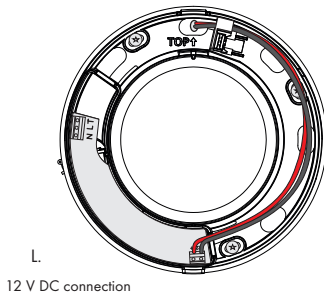
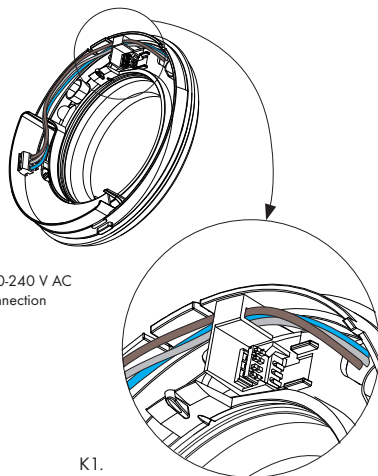

ELECTRICAL CONNECTION 100-240VAC

NOTE! Wiring of 100-240VAC must be performed by a qualified electrician.



NOTE! The integrated all-pole switch S only functions at 100-240VAC wiring.
Bluetooth LE: -12dBm EIRP (63µW), nominal 2450MHz.
Radio Equipment Directive (RED)

Svara auto:

100-240VAC 50 / 60Hz

Continuous trickle speed ventilation, automatic boost at elevated humidity levels, and via the integrated light sensor. Possibility to start / stop via manual switch T. Option of accelerated air flow rate with 15 minutes' run-on using manual switch T.

Svara on/off operation through remote switch, with overrun:

(Can be combined with backdraught shutter) 100-240VAC 50 / 60Hz Must be selected via Vent-Axia Connect App. Start / stop via manual switch T. (start = max. RPM, stop = 15 minutes run-on time)

Svara humidity controlled:

(Can be combined with backdraught shutter) 100-240VAC 50 / 60Hz Must be selected via Vent-Axia Connect App. Trickle setting, automatic start / stop on changes in humidity levels. Possibility to start / stop via manual switch T. (start = max. RPM, stop = 15 minutes run-on time)

NOTE: Vent-Axia hereby assure that this type of Bluetooth radio equipment complies with RED Directive 2014/53 / EU. The full text of the EU Declaration of Conformity can be found at the following URL: <http://bit.ly/2OyA8vY>



NOTE: With T switch activated, the fan always returns to max. speed after contact via app. Any changes are only activated when the T input is switched off and the run-on time has elapsed

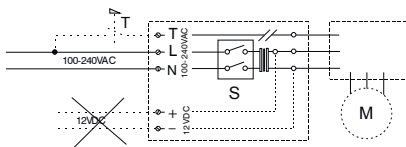

Svara on/off operation through remote switch:

(Can be combined with backdraught shutter) 100-240VAC 50 / 60Hz
Must be selected via Vent-Axia Connect App.
Start / stop via manual switch L.

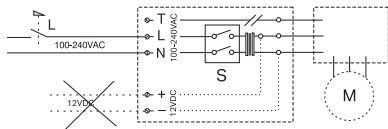



Connection of 100-240VAC and 12VDC cannot be done simultaneously (Figure N).

N.

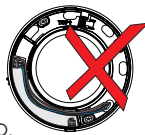

No 100-240V wiring may penetrate the electronics portion (Figure O.)

O.

ELECTRICAL CONNECTION 12VDC

NOTE. Vent-Axia recommends that electrical connection of 12 VDC be performed by a qualified electrician.



NOTE! 12VDC voltage must not exceed between 10 - 13,6VDC.

Svara auto:

12VDC (switch C always on)

Continuous trickle ventilation, automatic boost at elevated humidity levels, and via the integrated light sensor.

Svara on/off operation through remote switch:

(Can be combined with backdraught shutters)

12VDC

Must be selected via Vent-Axia Connect App.
Start / stop via manual switch C.

Svara humidity controlled:

(Can be combined with backdraught shutters)

12VDC (switch C always on)

Must be selected via Vent-Axia Connect App.

Trickle setting, automatic start / stop on changes in humidity levels.

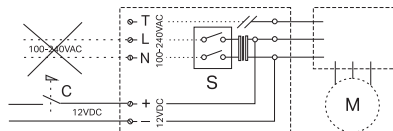

NOTE! For 12VDC always use switches intended for direct current, C.

Mounting the cover on the wall frame

- The fan is double insulated and must not be earthed. When the electrical connection is made place the cover back over the wall frame fitted into the housing hole (Figure P).

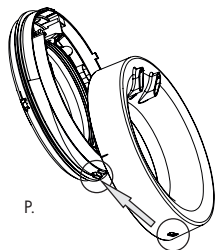

P.

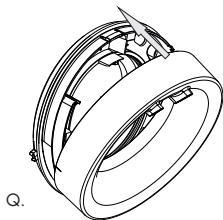

Q.

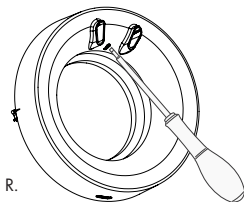

R.

- Next, fold the cover over the wall frame (Figure Q).
- Ensure the catch the screwdriver is pointing to (Figure R) engages properly.
- Make sure that the cover is firmly seated in the hook on the wall frame and latch by pulling a bit of cover.
- Finally put the motor unit in place (Figure S). Be careful when fitting motor unit, the impeller can be damaged if the unit is forced in at an angle.
- A distinct 'click' sound confirms that the device is in place, check that the integrated On switch works freely before turning on according to (Figure T).

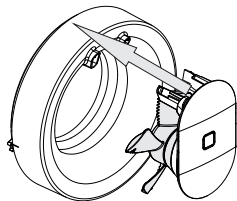

S.

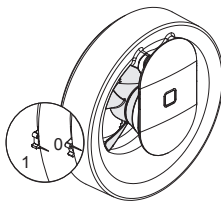

T.

Vent-Axia Svara®

Automatic functions and settings via app

Default setting:

Vent-Axia Svara is programmed to cope with the vast majority of installations.

The fan works continuously at a trickle flow of 10l/s.

When the fan senses somebody in the room it increases the flow to 16l/s.

If the humidity rises rapidly, for example when the shower is on, the fan goes up to maximum flow at 30l/s.

When the fan senses the humidity level has returned to normal it reverts to the trickle flow of 10l/s.

If other settings or functions are desired, download the Vent-Axia Connect App from the App Store and Google Play.

Requirements for functionality

Versions of the operating systems are updated continuously, for information go to: www.vent-axia.com/svara.

Fault indication:

Red LED on the fan indicates power failure when the calendar function has been activated.

Activate the app:

You have to use a code to activate the app, the code is unique for each fan. Enter the code or scan it through your phone. Your unique code is on the right leg of the motor unit (Figure T).

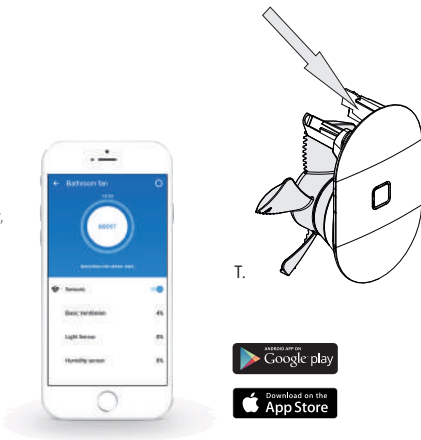

Learn more about all the possibilities with our app
at www.vent-axia.com/svara

Servicing and maintenance

WARNING: THE FAN AND ANCILLARY CONTROL EQUIPMENT MUST BE ISOLATED FROM THE POWER SUPPLY DURING MAINTENANCE.

Strong solvents should not be used on the fan.

The fan must not be dipped in or sprayed with water. For the fan to operate correctly it must be cleaned at least twice a year, more often if necessary.

- Before cleaning, switch off the power to the fan (Figure U).
- Loosen the motor unit by grasping it (Figure V), prise off the motor unit by leveraging the cap with your knuckles. Ensure that you have the motor unit in a secure grip so you do not drop it when it loosens.

- Clean opening, the duct and the motor unit with a damp cloth (if necessary, use a mild detergent).
- The impeller does not detach and should be wiped clean in its position on the motor housing
- If the fan has an external backdraught shutter the shutter should be cleaned gently.
- Replace the motor unit in the frame.

Eco

Discarded fans should be submitted as electronic waste to the recycling centre.

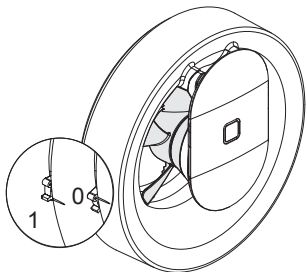

U.

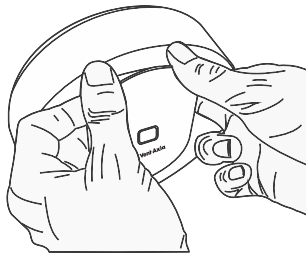

V.

The Vent-Axia Guarantee Safe Water Installation

Applicable only to products installed and used in the United Kingdom. For details of guarantee outside the United Kingdom contact your local supplier.

Vent-Axia guarantees its Lo-Carbon products for five years from date of purchase against faulty material or workmanship. In the event of any part being found to be defective, the product will be repaired, or at the Company's option replaced, without charge, provided that the product:

- Has been installed and used in accordance with the instructions given with each unit.
- Has not been connected to an unsuitable electricity supply. (The correct electricity supply voltage is shown on the product rating label attached to the unit).
- Has not been subjected to misuse, neglect or damage.
- Has not been modified or repaired by any person not authorised by the company.

IF CLAIMING UNDER TERMS OF GUARANTEE

Please return the complete product to your original supplier. The guarantee is offered to you as an extra benefit, and does not affect your legal rights.

This product conforms to industry regulations for electrical safety.

Supplier guarantees the functioning of the relevant regulations and instructions are complied with.

All the holes for the screws to be carried out according to the figures X and Y.

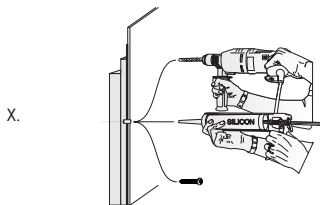

For Wallcoverings Wooden (Figure Y), drill only through the coating and waterproofing.

NOTE: Never drill through any plywood.

Fill the entire hole with age-resistant sealing compound.

Use plumbing screws, screw through the plywood into the regulatory framework.

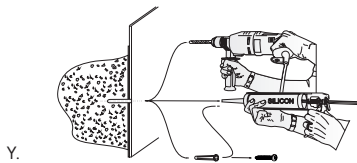

Vent-Axia®

Head Office:

Fleming Way, Crawley, West Sussex, RH10 9YX.

SALES ENQUIRIES:

Tel: 0844 8560590 Fax: 01293 565169

TECHNICAL SUPPORT:

Tel: 0344 8560594 Fax: 01293 532814

Pin Code for app

To access the application:

PIN-code for your fan can you find on the right leg of the motor unit. See page 9.

Write in the PIN-code into the square to the left to save it.

1. Fan Vent-Axia Svava- White
Stock Ref. 409802
2. Fan Vent-Axia Svava- Black
Stock Ref. 496711



Accessories available: (purchased separately)

1. Cover Plate - White
for duct dimensions between Ø140-160
Stock Ref. 409820
2. Cover Plate - Black
for duct dimensions between Ø140-160
Stock Ref. 497117
3. Internal Fit Wall Kit - White
with Backdraught Shutter
Stock Ref. 474779

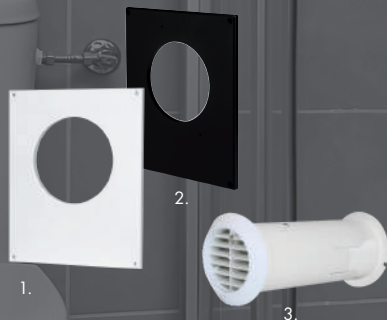

EU Authorised Representative:
Vent-Axia Bedrijvenweg 17 7442 CX Nijverdal
Nederland
authorisedrep@vent-axia.nl

© Copyright Vent-Axia®

We accept no liability for printing errors and reserve the right to make changes to materials and designs.

009-500011-H 2021-05-04
409821F