

Sensor-switched LED outdoor light











L 820 S

V2 Anthracite

EAN 4007841 035754

Article number 035754



-  Up-/Downlight
-  LED
-  3000 K
-  intelligent high frequency sensor
160°
-  1 - 5 m
-  IP44
-  2 - 1000 lux
-  5 sec - 15 min
-  soft light start
-  10% basic brightness

Function description

The most modern outdoor light in the world. Designer sensor-switched outdoor light L 820 S with invisible high-frequency sensor, ideal for building entrances and fronts of buildings, 9,8 W STEINEL LED lighting system, 679 lm, 160° coverage angle, reach from 1 - 5 m, for stylish up and downlighting with house number panel, includes soft light start and optional manual override for 4 hours.

L 820 S

V2 Anthracite

EAN 4007841 035754

Article number 035754

Technical specifications

Dimensions (L x W x H)	145 x 230 x 260 mm
Mains power supply	220 – 240 V / 50 – 60 Hz
Sensor Technology	iHF (intelligent high-frequency technology)
Transmitter power	
Output	9,8 W
Interconnection	No
Slave modeselectable	Yes
Lichtstrom Gesamtprodukt	679 lm
Gesamtprodukt Effizienz	69 lm/W
Colour temperature	3000 K
With lamp	Yes, LED lamp
Lamp	LED cannot be replaced
LED life expectancy (25 °C)	> 60000 h
Base	without
LED cooling system	Active and Passive Thermo Control
With motion detector	Yes
Detection angle	160 °
Capability of masking out individual segments	No
Electronic scalability	Yes
Mechanical scalability	No
Reach, radial	r = 5 m (35 m ²)

Reach, tangential	r = 5 m (35 m ²)
Continuous light	selectable, 4h
Photo-cell controller	Yes
Twilight setting	2 – 2000 lx
Time setting	5 s – 15 Min.
Basic light level function	Yes
Basic light level function time	10/30 min, all night
Functions	Motions sensor
Soft light start	Yes
Impact resistance	IK03
IP-rating	IP44
Protection class	II
Ambient temperature	-20 – 40 °C
Housing material	Aluminium
Cover material	Plastic, opal
Manufacturer's Warranty	3 years
Einstellungen via: Connect Bluetooth Mesh	Potentiometers
With remote control	No
Installation site	wall
Version	Anthracite
PU1, EAN	4007841035754

Dimension Drawing

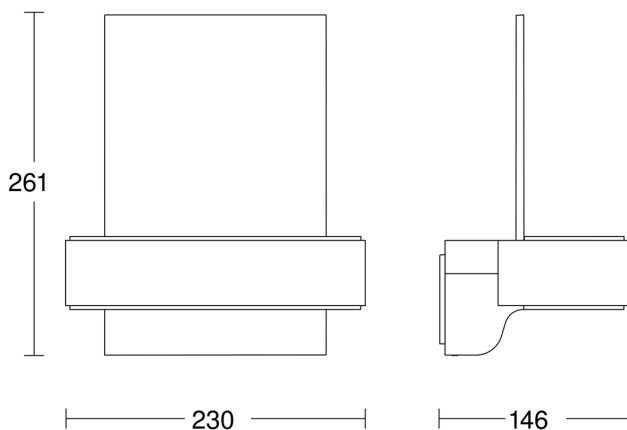

Circuit diagram

