

MANROSE®

Manufacturers of Ventilation Fans and Equipment

Ducting Catalogue 2023



A wide range of ducting and accessories - everything you need for the job



MANROSE®

Manrose Manufacturing continues to maintain its position at the forefront of the ventilation and fan equipment market. The company has been manufacturing practical, reliable ventilation equipment for over 35 years and credits its success to a simple philosophy of offering cost-effective, innovative products to suit any requirement.

Manrose's research and development team has consistently produced products that stand out from the rest, bringing them to market through a team of experienced professionals who understand the needs of our customers. Our policy of ongoing investment in product development has been a key force in driving the company to the top of the ventilation fans and equipment market.

Our facility in Reading is divided into administrative, sales and assembly areas, and is responsible for logistics on an ever-growing product range of over 2000 items.

Thanks to an understanding of local needs and standards, Manrose are able to design products that are ideally suited to UK installers and fully compliant with the latest legislation and regulatory standards. This commitment to quality has also enabled us to make highly profitable inroads into the Far Eastern markets, reversing the general trend and creating more exports for the UK. This is clear evidence that the benefits of innovative design, ease of installation, energy efficiency and sensible pricing we bring to the UK market are also appreciated further afield.

At the heart of Manrose's operation is a total commitment to the UK market, evidenced by the ongoing expansion of manufacturing facilities. Our production facility operates 32 state-of-the-art moulding machines, ranging from 25 tonnes to 450 tonnes, with the recent addition of new 100 Ton, 250 Ton and 270 Ton machines. Our capabilities also include three extrusion machines for rigid flat channel ducting, as well as three machines for the production of flexible PVC and one machine for Semi Rigid aluminium foil ducting.

A sealed cooling system for the machinery allows the facility to operate its 18 fan assembly, and 8 kitting and packaging lines 24 hours a day, developing and manufacturing new families of fans encompassing domestic, commercial and industrial applications. The facility includes fully automated drying and material feed system, an automatic colour dosing system and state of the art conveyor systems that delivers mouldings to a central position for sorting, checking and packing.

Close to the M4 in Reading, our fleet of vehicles provides fast access to the country's main arteries, ensuring quick delivery from our extensive warehouses.

Manrose's innovations are the result of listening to customers and understanding their needs. With energy efficiency now a prime consideration, and often compulsory for new buildings, we have ensured that all of our products offer optimum performance, as well as introducing added value features such as the humidistat controlled fan.

The humidistat fan is controlled in relation to humidity levels in the space rather than a pre-set run time so the fan keeps running until the humidity goes below the set point. This ensures that the space is thoroughly ventilated without wasting energy through over-ventilating. Similar efficiency improvements are afforded by our occupancy-controlled fans, which switch off when the space has been vacated for a pre-set time. By enabling fans to interact with their environment in this way, Manrose provides end users with a high level of comfort with minimal cost of ownership.

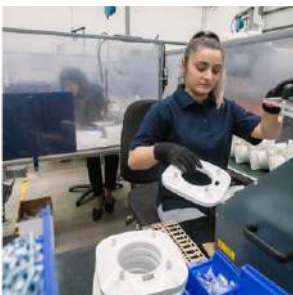
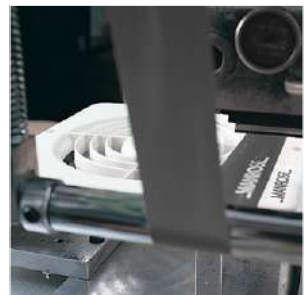

Ducting - Insulated

DUCTING - INSULATED



WHAT IS CONDENSATION?

Condensation is when water vapours make contact with a cold surface and form into liquid, the opposite of evaporation.

Condensation is a serious problem which affects millions of households in the UK.

- Condensation can cause mould and damp, which could lead to serious health risks and affect general wellbeing; asthma, bronchitis and various other respiratory problems
- Can cause wallpaper to peel
- Can contribute to severe structural damage (wood rot & damp)

HOW DO I PREVENT CONDENSATION?

Condensation and damp can be reduced and controlled if you change the habits implemented within your home.

- Washed clothes should be dried outdoors
- Keep doors to bathrooms shut to avoid moisture getting to other parts of the house
- When cooking, cover pots and pans
- Ensure adequate mechanical ventilation (extractor fans)
- Tumble driers should be vented to the atmosphere

HOW WOULD INSULATED DUCTING PROTECT MY HOME?

Ducting in most cases is located within cold, unheated areas of the home, and in most cases not insulated!

Insulated Ducting:

- Retains ambient temperature of room thus preventing steam condensing back into water
- Stops condensed water from dripping back into the property
- Can prevent escalation of structural damage
- Is ideal for vertical installations

Complies with the Domestic Ventilation Compliance Guide.



Deluxe Quick Internal Fit Wall Kit Domestic Range

DELUXE QUICK INTERNAL FIT WALL KIT



The NEW Manrose Deluxe Quick Internal Fit Wall Kit can be installed entirely from the inside of a property, reducing installation time and removing the need for costly and time consuming external grille fitting involving scaffolding.

This innovative new wall kit includes an adjustable wall liner and external grille with a rubber seal on the outside of the building.

The wall kit can be adjusted to wall thicknesses anywhere between 225mm and 390mm - just measure the wall, then use the guide on the tube of the wall kit to set it to the correct length.

Simply insert the tube into the hole, deploy the external grille and 3 pins will hold the wall kit securely in place. The external grille and seal can then be pulled back against the external wall so a tight fit can be achieved.

The external rubber seal covers up any break-out on the external hole and leaves a clean, tidy finish. In addition, the rubber seal will help to protect against water ingress.

The wall kit is also suitable as a passive air inlet grille.

Patented design.

Technical Details

Cat. No.

DHRIWKW - White

Product type

Deluxe Quick Internal Fit Wall Kit with White external grille and rubber seal.

DHRIWKB – Brown

Deluxe Quick Internal Fit Wall Kit with Brown external grille and rubber seal.

DHRIWKWBS - White

Deluxe Quick Internal Fit Wall Kit with White external grille and rubber seal with Backdraught Shutter.

DHRIWKBBS – Brown

Deluxe Quick Internal Fit Wall Kit with Brown external grille and rubber seal with Backdraught Shutter.

Packaging

All models packaged in outers of 1. Contact our technical department for packaging dimensions.

Installation

Designed to fit through the wall in a 117mm hole with a maximum depth of 390mm and a minimum depth of 225mm. Can be used with any 100mm fan - select model without integral backdraught shutter if fan already has them.

Dimensions (mm)

Min wall thickness: 225mm

Max wall thickness: 390mm

Hole diameter: 117mm

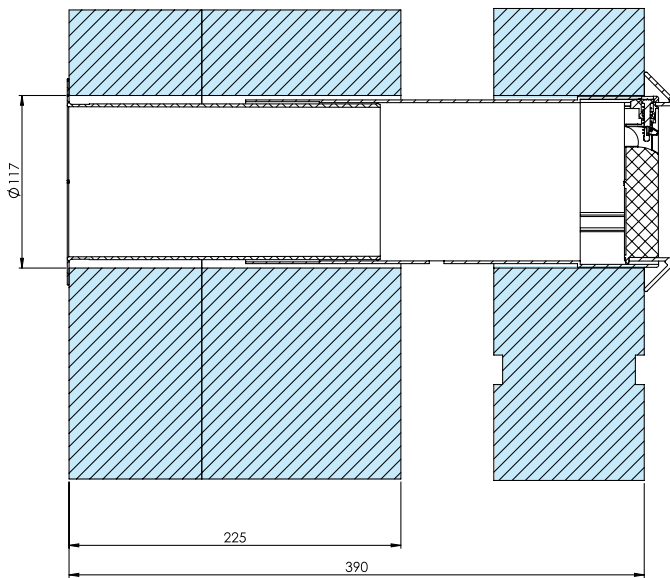

Rubber seal gives neat finish

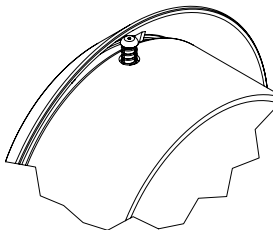

Locking pins secure wall kit in place

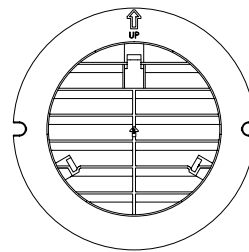

Fixed external grille

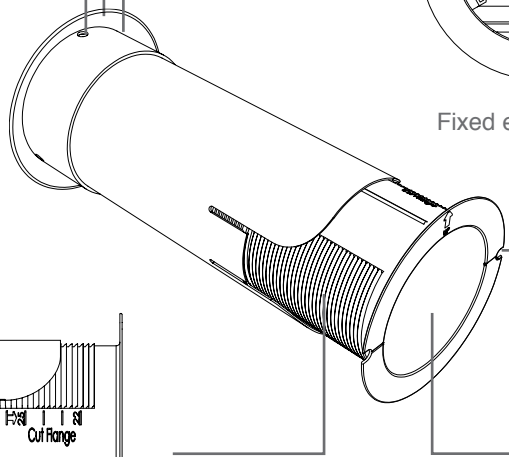

Screw fixings to secure in place

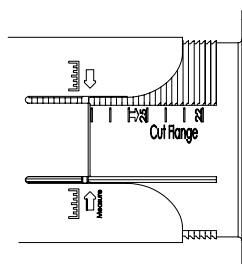

Easy to use measurement guide for flexible installation depth



Integral backdraught shutter (BS models)

MANROSE®

Ducting - Terminations

Wall Grilles available in White & Brown. Please state colour.

Gravity Shutter Grille

Round Spigot - External Wall Grille



Cat. No.	Product Type	Size
1162	140 x 140mm Gravity Shutter Grille	100mm/4"
1182	160 x 160mm Gravity Shutter Grille	125mm/5"
1202	180 x 180mm Gravity Shutter Grille	150mm/6"
1209FG	286 x 286mm Gravity Shutter Grille	230mm/9"
1206FG	362 x 362mm Gravity Shutter Grille	300mm/12"

Weather Proof Cowled Wall Outlet

With Damper - Round Spigot



Cat. No.	Product Type	Size
1240	Vent Hoods/Weatherproof Cowls	100mm/4"
1241	Vent Hoods/Weatherproof Cowls	125mm/5"
1242	Vent Hoods/Weatherproof Cowls	150mm/6"

Fixed Louvre Grille

External Wall Grille - Round Spigot



Cat. No.	Product Type	Size
1152	140 x 140mm Fixed Louvre Grille	100mm/4"
1172	160 x 160mm Fixed Louvre Grille	125mm/5"
1192	180 x 180mm Fixed Louvre Grille	150mm/6"
1209*	286 x 286mm Fixed Louvre Grille	230mm/9"
1206*	362 x 362mm Fixed Louvre Grille	300mm/12"

*Available in White only.

Egg Crate Grille

Round Spigot - External Wall Grille



Cat. No.	Product Type	Size
1145L*	140 x 140mm Egg Crate Grille	100mm/4"
1147L*	160 x 160mm Egg Crate Grille	125mm/5"
1148L*	180 x 180mm Egg Crate Grille	150mm/6"

*Available in Brown only.

Egg Crate Grille

Rectangular Spigot - External Wall Grille



Cat. No.	Product Type	Size
1146	140 x 140mm Egg Crate Grille	110 x 54mm

Fixed Louvre Grille (Two Piece)*

Round Spigot



Cat. No.	Product Type	Size
9152	140 x 140mm Fixed Louvre Grille	100mm/4"
9192	180 x 180mm Fixed Louvre Grille	150mm/6"

*Please note the two piece wall grille is not part L compliant.

Plate Grilles*

External Plate Wall Grilles



Cat. No.	Product Type	Size
1210L	200 x 200mm Grille Fixed Louvre	150mm/6"
1220L	200 x 200mm Grille Gravity Shutters	150mm/6"
1208	286 x 286mm Grille Fixed Louvre	230mm/9"
1207	362 x 362mm Grille Fixed Louvre	300mm/12"

* Available in White only

Multi Fit Grilles

Dual fitting for Round and Rectangular Ducting



Cat. No.	Product Type	Size
41031	A-Cowled Outlet - dual fitting	100mm/4"
41051	B-Fixed Louvre - dual fitting	100mm/4"
41011	C-Gravity Shutters - dual fitting	100mm/4"

*Available in White only.

Fly Screen*

For fixed Wall Grilles



Cat. No.	Product Type	Size
FS100	Fly Screen	100mm/4"
FS120	Fly Screen	120mm/5"
FS150	Fly Screen	150mm/6"

*We don't recommend the use of fly screens with mechanical extract ventilation. It can reduce the fans performance by up to 60% leaving the fan no longer complying with the building regulation doc Part F & L. Only for use with static-vent and return air boxes.

For information please contact our technical department.

Internal Door Ventilator

Plastic Fixed Vent



Cat. No.	Product Type	Product Size
41450	Internal Door Ventilator	452x90mm

Adjustable Vent

PVC Fully Adjustable Vent



Cat. No.	Product Type	Size
1800	PVC Adjustable Vent	250x81mm
1810	PVC Adjustable Vent	250x166mm
1820	PVC Adjustable Vent	250x250mm
1810C	Chrome Plated Vent	250x166mm
1820C	Chrome Plated Vent	250x250mm

Fixed Louvre Vent

White PVC Vent for Maximum Flow



Cat. No.	Product Type	Size
1830	Fixed Louvre Vent	229x76mm
1840	Fixed Louvre Vent	229x152mm

Internal Circular Egg Crate Grilles

Cat. No.	Product Type	Size
3100W	Circular Egg Crate Grilles - White	100mm/4"
3100C	Circular Egg Crate Grilles - Chrome	100mm/4"



Ducting - Terminations

Internal Circular Grilles



Cat. No.	Product Type	Size
2100W	Circular Grilles - White	100mm/4"
2100C	Circular Grilles - Chrome	100mm/4"
2120W	Circular Grilles - White	120mm/5"
2120C	Circular Grilles - Chrome	120mm/5"
2150W	Circular Grilles - White	150mm/6"
2150C	Circular Grilles - Chrome	150mm/6"



External Round Louvred Grilles



Cat. No.	Product Type	Size
41020*	Round Louvred Grille	100mm/4"
51020	Round Louvred Grille	125mm/5"
61020	Round Louvred Grille	150mm/6"

*Brown unavailable.

Circular Air Diffusers

Duct Valves with Spring Connection & Fully Adjustable Centre Disc



Cat. No.	Product Type	Size
1250	Duct Valves with Spring Connection	100mm/4"
1251	Duct Valves with Spring Connection	120mm/5"
1260	Duct Valves with Spring Connection	150mm/6"
1259	Duct Valves with Spring Connection	200mm/8"

Extract Ventilation Pipes



Weathering Collar

Cat. No.	Product Type	Size
1420	Extract Ventilation Pipes	110mm

Extract Cover



Roof Cowl for Extract Ventilation Pipes

Cat. No.	Product Type	Size
1430	Extract Cover	110mm

Through Roof Vent Kit



Complete with Weathering Slate, 100mm Roof Cowl and 500mm of Soil Pipe. Use 40419 adapter if connecting to 100mm ventilation ducting.

Cat. No.	Product Type	Size
1380	110mm Angled 457x457	110mm
1390	110mm Flat 406x406	110mm

Weathering Slates - Aluminium



Cat. No.	Product Type	Size
1400	110mm Angled 457x457	110mm
1410	110mm Flat 406x406	110mm

Five in One Roof Vent Kit



500 x 500mm lead through roof 5 way ventilation terminal available in dark grey

Cat. No.	Product Type	Size
1395	Duct Sizes 100/110/125/150/160	150/160mm

Ducting - Rectangular Rigid

Flat Channel Ducting



Cat. No.	Product Type	External Dimensions (mm)			Resistance (Pa) at flow rate								
		H	W	D	8 l/s	13 l/s	21 l/s	29 l/s	37 l/s	45 l/s	53 l/s	61 l/s	
40100	110 x 54mm - L1000mm	54	110	1000	0.8	1.6	3.5	6.0	9.2	13.1	17.1	21.1	
40150	110 x 54mm - L1500mm	54	110	1500	1.2	2.4	5.3	9.1	13.9	19.8	25.9	32	
44020	110 x 54mm - L2000mm	54	110	1500	-	-	-	-	-	-	-	-	
58100	150 x 70mm - L1000mm	70	150	1000	-	-	-	-	-	-	-	-	
58150	150 x 70mm - L1500mm	70	150	1500	-	-	-	-	-	-	-	-	
58030	150 x 70mm - L300mm	70	150	300	-	-	-	-	-	-	-	-	
58040	150 x 70mm - L400mm	70	150	400	-	-	-	-	-	-	-	-	
55100	204 x 60mm - L1000mm	60	204	1000	<1	<1	<1	1.5	2.2	3.0	3.9	5.1	
55150	204 x 60mm - L1500mm	60	204	1500	<1	<1	1.3	2.2	3.3	4.5	5.9	7.8	
55020	204 x 60mm - L2000mm	60	204	1500	-	-	-	-	-	-	-	-	
Cat. No.	Product Type	H	W	D	60 l/s			120 l/s			180 l/s		
60910	220 x 90mm - L1000mm	90	220	1000	0.9			3.2			6.7		
60915	220 x 90mm - L1500mm	90	220	1500	1.4			4.9			10.2		
60902	220 x 90mm - L2000mm	90	220										
1501	225 x 25mm - L1000mm	25	225	1000	-			-			-		
1503	225 x 25mm - L1500mm	25	225	1500	-			-			-		
1502	225 x 25mm - L2000mm	25	225	2000	-			-			-		
1500	225 x 25mm - L2400mm	25	225	2400	-			-			-		
1509	300 x 25mm - L1000mm	25	300	1000	-			-			-		
1508	300 x 25mm - L1500mm	25	300	1500	-			-			-		
1510	300 x 25mm - L2000mm	25	300	2000	-			-			-		
1515	300 x 25mm - L2400mm	25	300	2400	-			-			-		

Horizontal 90° Bend

Rectangular Horizontal Bend with Female Fittings Suitable for above Kitchen cupboards



Cat. No.	Product Type	External Dimensions (mm)			Resistance (Pa) at flow rate								
		H	W	D	8 l/s	13 l/s	21 l/s	29 l/s	37 l/s	45 l/s	53 l/s	61 l/s	
40500	110 x 54mm	60	152	152	2.3	9.9	21	38	64	93	124	162	
58500	150 x 70mm	-	-	-	-	-	-	-	-	-	-	-	
55500**	204 x 60mm	65	260	260	<1	1.7	4.1	8.4	13	18	25	34	
Cat. No.	Product Type	H	W	D	60 l/s			120 l/s			180 l/s		
60950	220 x 90mm	95	250	250	9			36			80		
1540	225 x 25mm	-	-	-	-			-			-		
1550	300 x 25mm	-	-	-	-			-			-		

Horizontal 45° Bend

Rectangular Horizontal Bend with Female Fittings Suitable for above Kitchen cupboards



Cat. No.	Product Type	External Dimensions (mm)			Resistance (Pa) at flow rate								
		H	W	D	8 l/s	13 l/s	21 l/s	29 l/s	37 l/s	45 l/s	53 l/s	61 l/s	
40450	110 x 54mm	-	-	-	-	-	-	-	-	-	-	-	
55810**	204 x 60mm	65	240	260	0.2	0.7	1.2	2.1	3.8	6.1	9.2	13	
Cat. No.	Product Type	H	W	D	60 l/s			120 l/s			180 l/s		
60953	220 x 90mm	95	240	200	5			20			46		
1560	225 x 25mm	-	-	-	-			-			-		
1570	300 x 25mm	-	-	-	-			-			-		

Adjustable Horizontal Bend

For connecting to Flat Channel Ducting



Cat. No.	Product Type	External Dimensions (mm)			Resistance (Pa) at flow rate								
		H	W	D	8 l/s	13 l/s	21 l/s	29 l/s	37 l/s	45 l/s	53 l/s	61 l/s	
54500	204 x 60mm	-	-	-	-	-	-	-	-	-	-	-	

Vertical 90° Bend

90° Rectangular Vertical Bend with Female Fittings suitable for above Kitchen cupboards



Cat. No.	Product Type	External Dimensions (mm)			Resistance (Pa) at flow rate								
		H	W	D	8 l/s	13 l/s	21 l/s	29 l/s	37 l/s	45 l/s	53 l/s	61 l/s	
40600	110 x 54mm	95	115	95	3.3	15.5	36	61	96	138	190	253	
58600	150 x 70mm	-	-	-	-	-	-	-	-	-	-	-	
55600**	204 x 60mm	115	210	115	1.1	2.5	5.2	9.8	16.1	24	33.6	45	
Cat. No.	Product Type	H	W	D	60 l/s			120 l/s			180 l/s		
60960	220 x 90mm	117	224	120	7			28			66		
1600	225 x 25mm	-	-	-	-			-			-		
1610	300 x 25mm	-	-	-	-			-			-		

45° Vertical Bend



Cat. No.	Product Type	External Dimensions (mm)			Resistance (Pa) at flow rate								
		H	W	D	8 l/s	13 l/s	21 l/s	29 l/s	37 l/s	45 l/s	53 l/s	61 l/s	
40045	110 x 54mm	-	-	-	-	-	-	-	-	-	-	-	
55645**	204 x 60mm	-	-	-	-	-	-	-	-	-	-	-	
Cat. No.	Product Type	H	W	D	60 l/s			120 l/s			180 l/s		
60963	220 x 90mm	110	225	115	6			27			65		
1670	225 x 25mm	-	-	-	-			-			-		
1690	300 x 25mm	-	-	-	-			-			-		

**This part comes in Grey. Whilst we will look to maintain the colour of Grey, by the nature of adopting a recycled plastic the colour and shade may vary at any given time.



Ducting - Rectangular Rigid

Horizontal T-Piece - Adaptor to Connect Flat Channel Ducting



Cat. No.	Product Type	Size	Resistance (Pa) at flow rate								
			8 l/s	13 l/s	21 l/s	29 l/s	37 l/s	45 l/s	53 l/s	61 l/s	
40080	110 x 54mm	110 x 54mm	vary on installation								
55582**	204 x 60mm	204 x 60mm	vary on installation								
60955	220 x 90mm	220 x 90mm	vary on installation								

Cross Over Duct Connector



Cat. No.	Product Type	External Dimensions (mm)			Resistance (Pa) at flow rate								
		H	W	D	8 l/s	13 l/s	21 l/s	29 l/s	37 l/s	45 l/s	53 l/s	61 l/s	
442273	30° Drop Down Connection	120	220	210	0.2	0.5	1.7	3.6	6.0	9.1	12.4	16.6	

Rectangular Wall Plate



Cat. No.	Product Type	External Dimensions (mm)			Resistance (Pa) at flow rate								
		H	W	D	8 l/s	13 l/s	21 l/s	29 l/s	37 l/s	45 l/s	53 l/s	61 l/s	
41150	154 x 154mm	154	154	-	n/a	n/a	n/a	n/a	n/a	n/a	n/a	n/a	
58650	172 x 172mm	172	172	-	n/a	n/a	n/a	n/a	n/a	n/a	n/a	n/a	
51150	119 x 264mm	119	264	-	n/a	n/a	n/a	n/a	n/a	n/a	n/a	n/a	

Flat Channel Connector



Cat. No.	Product Type	External Dimensions (mm)			Resistance (Pa) at flow rate								
		H	W	D	8 l/s	13 l/s	21 l/s	29 l/s	37 l/s	45 l/s	53 l/s	61 l/s	
40200	110 x 54mm	54	114	100	<1	<1	1.1	1.4	2.2	3.4	4.8	6.4	
58200	150 x 70mm	-	-	-	-	-	-	-	-	-	-	-	
55200**	204 x 60mm	64	212	100	<1	<1	<1	<1	<1	<1	1.2	1.5	
1520	225 x 25mm	-	-	-	-	-	-	-	-	-	-	-	
1530	300 x 25mm	-	-	-	-	-	-	-	-	-	-	-	
Cat. No.	Product Type	H	W	D	60 l/s			120 l/s			180 l/s		
60920	220 x 90mm	95	224	52	<1			<1			<1		

Flat Channel Connector with Internal Damper



Cat. No.	Product Type	External Dimensions (mm)			Resistance (Pa) at flow rate								
		H	W	D	8 l/s	13 l/s	21 l/s	29 l/s	37 l/s	45 l/s	53 l/s	61 l/s	
40270	110 x 54mm - with Damper	60	115	75	16	17.5	19.5	22	25.5	30.5	36	42	

Rigid Duct Attenuator



Cat. No.	Product Type	Size	Resistance (Pa) at flow rate									
			8 l/s	13 l/s	21 l/s	29 l/s	37 l/s	45 l/s	53 l/s	61 l/s		
SL55105	0.6m Length	204 x 60mm	<1	<1	2.3	4.2	-	-	-	-	-	12.2
SL55100	1.0m Length	204 x 60mm	<1	<1	2.2	4.1	-	-	-	-	-	15

Insulated Rectangular Duct



Cat. No.	Product Type	Size	Resistance (Pa) at flow rate									
			8 l/s	13 l/s	21 l/s	29 l/s	37 l/s	45 l/s	53 l/s	61 l/s		
IJRP55150	1.5m Length	204 x 60mm	<1	<1	1.3	2.2	3.3	4.5	5.9	7.8	-	-
IJRP55020	2.0m Length	204 x 60mm	-	-	-	-	-	-	-	-	-	-
IJRP60915	1.5m Length	220 x 90mm	-	-	-	-	-	-	-	-	-	-
IJ204-1.5	1.5m Length Jacket	204 x 60mm	-	-	-	-	-	-	-	-	-	-
IJ204-2	2.0m Length Jacket	204 x 60mm	-	-	-	-	-	-	-	-	-	-
IJ220-1.5	1.5m Length Jacket	220 x 90mm	-	-	-	-	-	-	-	-	-	-

Insulated Vertical Bend



Cat. No.	Product Type	Size	Resistance (Pa) at flow rate									
			8 l/s	13 l/s	21 l/s	29 l/s	37 l/s	45 l/s	53 l/s	61 l/s		
IJBV55645	Vertical 45° Bend	204 x 60mm	0.1	0.5	1.3	2.5	4.4	6.9	10	13.3	-	-
IJBV55600	Vertical 90° Bend	204 x 60mm	1.1	2.5	5.2	9.8	16.1	24	33.6	45	-	-
IJV204-90	Vertical 90° Bend Jacket	204 x 60mm	-	-	-	-	-	-	-	-	-	-

Insulated Horizontal Bend



Cat. No.	Product Type	Size	Resistance (Pa) at flow rate									
			8 l/s	13 l/s	21 l/s	29 l/s	37 l/s	45 l/s	53 l/s	61 l/s		
IJBH55810	Horizontal 45° Bend	204 x 60mm	0.2	0.7	1.2	2.1	3.8	6.1	9.2	13	-	-
IJBH55500	Horizontal 90° Bend	204 x 60mm	0.7	1.7	4.1	8.4	13	18	25	34	-	-
Cat. No.	Product Type	Size	60 l/s			120 l/s			180 l/s			
IJBH60950	Horizontal 90° Bend	220 x 90mm	9			36			80			
IJ220-90	90° Bend Jacket	220 x 90mm	-			-			-			

Insulated T-Piece Bend



Cat. No.	Product Type	Size	Resistance (Pa) at flow rate								
			8 l/s	13 l/s	21 l/s	29 l/s	37 l/s	45 l/s	53 l/s	61 l/s	
IJTH55582	T-Piece	204 x 60mm	vary on installation								

**This part comes in Grey. Whilst we will look to maintain the colour of Grey, by the nature of adopting a recycled plastic the colour and shade may vary at any given time.

Ducting - Adaptors

Elbow 90° Bend M to F

Connector for joining Round Pipe, Flexi Hose & Flat Channel Ducting



Cat. No.	Product Type	External Dimensions (mm)			Resistance (Pa) at flow rate							
		H	W	D	8 l/s	13 l/s	21 l/s	29 l/s	37 l/s	45 l/s	53 l/s	61 l/s
40300 (F)	100mmØ to 110 x 54mm	90	115	140	3	8	17.7	33	49.9	74.5	101	137
40400 (M)	100mmØ to 110 x 54mm	-	-	-	-	-	-	-	-	-	-	-
58400	125mmØ to 150 x 70mm	-	-	-	-	-	-	-	-	-	-	-
54400	100mmØ to 204 x 60mm	80	215	195	2.9	7.1	15.1	28	45.1	68.1	92.2	118
55400**	125mmØ to 204 x 60mm	80	215	195	3.1	5.9	12.2	25	43.6	62.2	86	111
56400**	150mmØ to 204 x 60mm	80	215	195	2.8	4.9	11.6	21	31	41	53	67
60941	100mmØ to 220 x 90mm	118	226	240	-	-	-	-	-	-	-	-
60951	125mmØ to 220 x 90mm	118	226	240	-	-	-	-	-	-	-	-
60961	150mmØ to 220 x 90mm	11	226	240	-	-	-	-	-	-	-	-

Short to Round Rectangular Adaptor

with male/female adaptors for Connecting Flat Channel Ducting to Round Hose



Cat. No.	Product Type	External Dimensions (mm)			Resistance (Pa) at flow rate							
		H	W	D	8 l/s	13 l/s	21 l/s	29 l/s	37 l/s	45 l/s	53 l/s	61 l/s
40700	100mm to 110 x 54mm (F)	60	110	105	1.2	4.3	8.4	20	30.2	43	62	88
40710	100mm to 110 x 54mm (M)	60	110	105	1.2	4.3	8.4	20	30.2	43	62	88

Round to Rectangular Adaptor - Adaptor to Connect Flat Channel Ducting



Cat. No.	Product Type	External Dimensions (mm)			Resistance (Pa) at flow rate							
		H	W	D	8 l/s	13 l/s	21 l/s	29 l/s	37 l/s	45 l/s	53 l/s	61 l/s
40701	100mmØ to 110 x 54mm	100	115	180	1.2	4.2	8.3	19.8	29.9	42	60	86
58701	125mmØ to 150 x 70mm	-	-	-	-	-	-	-	-	-	-	-
55710**	100mmØ to 204 x 60mm	140	210	215	1.0	1.96	3.2	4.9	6.7	8.7	11.2	14.5
55700**	125mmØ to 204 x 60mm	140	210	213	<1	<1	1.5	2.8	4.5	6.7	9	11.5
60970	150mmØ to 220 x 90mm	160	225	203	-	-	-	-	-	-	-	-

Adaptor - Adaptor to Connect Round Pipe Ducting



Cat No.	Product Type	External Dimensions (mm)			Resistance (Pa) at flow rate							
		H	W	D	8 l/s	13 l/s	21 l/s	29 l/s	37 l/s	45 l/s	53 l/s	61 l/s
54544	125mm to 100mm	-	-	-	-	-	-	-	-	-	-	-

Offset Reducer

Adaptor to Connect Round Pipe Ducting



Cat No.	Product Type	External Dimensions (mm)			Resistance (Pa) at flow rate							
		H	W	D	8 l/s	13 l/s	21 l/s	29 l/s	37 l/s	45 l/s	53 l/s	61 l/s
45644	150mm to 125mm or 100mm	-	-	-	-	-	-	-	-	-	-	-

Circular Reducer

Adaptor to Connect Round Pipe Ducting, Flexi Hose & Fan Spigots



Cat No.	Product Type	External Dimensions (mm)			Resistance (Pa) at flow rate							
		H	W	D	8 l/s	13 l/s	21 l/s	29 l/s	37 l/s	45 l/s	53 l/s	61 l/s
54119	125mm to 100mm	-	-	-	-	-	-	-	-	-	-	-
64619	150mm to 100mm	-	-	-	-	-	-	-	-	-	-	-
65118	150mm to 125mm	-	-	-	-	-	-	-	-	-	-	-
86117	200mm to 150mm	-	-	-	-	-	-	-	-	-	-	-
98116	250mm to 200mm	-	-	-	-	-	-	-	-	-	-	-
12800	300mm to 200mm	-	-	-	-	-	-	-	-	-	-	-
40419	110mm to 100mm	-	-	-	-	-	-	-	-	-	-	-

Plenum Cooker Hood/Fan - with Connector



Cat No.	Product Type	External Dimensions (mm)			Resistance (Pa) at flow rate							
		H	W	D	8 l/s	13 l/s	21 l/s	29 l/s	37 l/s	45 l/s	53 l/s	61 l/s
1640	100mm to 225mm	-	-	-	-	-	-	-	-	-	-	-
1650	100mm to 300mm	-	-	-	-	-	-	-	-	-	-	-
1645	120mm to 225mm	-	-	-	-	-	-	-	-	-	-	-
1655	120mm to 300mm	-	-	-	-	-	-	-	-	-	-	-

Round to Rectangular Adaptor - Requires 414C Connector



Cat No.	Product Type	External Dimensions (mm)			Resistance (Pa) at flow rate							
		H	W	D	8 l/s	13 l/s	21 l/s	29 l/s	37 l/s	45 l/s	53 l/s	61 l/s
40725	100mm to 225 x 25mm	-	-	-	-	-	-	-	-	-	-	-
40730	105mm to 300 x 25mm	-	-	-	-	-	-	-	-	-	-	-

Double Airbrick



Cat No.	Product Type	External Dimensions (mm)			Resistance (Pa) at flow rate							
		H	W	D	8 l/s	13 l/s	21 l/s	29 l/s	37 l/s	45 l/s	53 l/s	61 l/s
60905W	220 x 90mm White	145	245	80	0.2	1.6	4.3	8.7	13.9	21.1	27.5	37.4
60905B	220 x 90mm Brown	145	245	80	0.2	1.6	4.3	8.7	13.9	21.1	27.5	37.4
60905CS	220 x 90mm Cotswold St.	145	245	80	0.2	1.6	4.3	8.7	13.9	21.1	27.5	37.4
60905T	220 x 90mm Terracotta	145	245	80	0.2	1.6	4.3	8.7	13.9	21.1	27.5	37.4

Double Airbrick Adaptor to Rectangular Duct

Fits High Performance Ducting 220 x 90mm to double Airbrick 60905



Cat No.	Product Type	External Dimensions (mm)			Resistance (Pa) at flow rate							
		H	W	D	8 l/s	13 l/s	21 l/s	29 l/s	37 l/s	45 l/s	53 l/s	61 l/s
60977	Double Airbrick Adaptor	-	-	-	-	-	-	-	-	-	-	-

**This part comes in Grey. Whilst we will look to maintain the colour of Grey, by the nature of adopting a recycled plastic the colour and shade may vary at any given time.



Ducting - Adaptors



Double Airbrick Adaptor to Round Duct

Fits 100/125/150mm Round Pipe

Cat No.	Product Type	External Dimensions (mm)			Resistance (Pa) at flow rate						
		H	W	D	60 l/s	120 l/s	180 l/s				
60954	Double Airbrick Adaptor	-	-	-	-	-	-	-	-	-	-



High Performance Ducting Adaptor

Fits 125 Channel Ducting 220x90mm to High Performance Ducting

Cat No.	Product Type	External Dimensions (mm)			Resistance (Pa) at flow rate							
		H	W	D	8 l/s	13 l/s	21 l/s	29 l/s	37 l/s	45 l/s	53 l/s	61 l/s
60957	Adaptor	-	-	-	-	-	-	-	-	-	-	-



Airbrick Adaptor

To connect Flat Channel Ducting and Airbrick Ventilators

Cat No.	Product Type	External Dimensions (mm)			Resistance (Pa) at flow rate							
		H	W	D	8 l/s	13 l/s	21 l/s	29 l/s	37 l/s	45 l/s	53 l/s	61 l/s
1580	Adaptor	-	-	-	-	-	-	-	-	-	-	-
1590	Adaptor	-	-	-	-	-	-	-	-	-	-	-



Extended Horizontal Airbrick - For 225mm to 300mm System

Cat No.	Product Type	External Dimensions (mm)			Resistance (Pa) at flow rate							
		H	W	D	8 l/s	13 l/s	21 l/s	29 l/s	37 l/s	45 l/s	53 l/s	61 l/s
1572	Fits Direct to Flat Channel	-	-	-	-	-	-	-	-	-	-	-
1573	Fits Direct to Flat Channel	-	-	-	-	-	-	-	-	-	-	-



Slimline Airbrick

Cat. No.	Product Type	Size	Resistance (Pa) at flow rate							
			8 l/s	13 l/s	21 l/s	29 l/s	37 l/s	45 l/s	53 l/s	61 l/s
45010*	Horizontal Louvre	110x54mm	-	-	-	-	-	-	-	-

* Fits into airbrick adaptor - 40770, 1572, 1573, 1580, 1590. Brown unavailable.



Slimline Airbrick

Wall Outlet

Cat. No.	Product Type	Size	Resistance (Pa) at flow rate							
			8 l/s	13 l/s	21 l/s	29 l/s	37 l/s	45 l/s	53 l/s	61 l/s
55010	Horizontal Louvre	204x60mm	-	-	-	-	-	-	-	-
55011*	Vertical Louvre	204x60mm	-	-	-	-	-	-	-	-
55012	Low resistance airbrick	204x60mm	-	-	-	-	-	-	-	-

*Available in White only.



Slimline Airbrick with Internal Damper

Cat. No.	Product Type	Size	Resistance (Pa) at flow rate							
			8 l/s	13 l/s	21 l/s	29 l/s	37 l/s	45 l/s	53 l/s	61 l/s
55501	Horizontal Louvre	204x60mm	-	-	-	-	-	-	-	-



Airbrick Adaptor

For use with Flat Channel Ducting and Slimline Air Bricks

Cat. No.	Product Type	Size	Resistance (Pa) at flow rate							
			8 l/s	13 l/s	21 l/s	29 l/s	37 l/s	45 l/s	53 l/s	61 l/s
40770*	Airbrick Adaptor	110x54mm	-	-	-	-	-	-	-	-

* Fits airbrick 45010

**This part comes in Grey. Whilst we will look to maintain the colour of Grey, by the nature of adopting a recycled plastic the colour and shade may vary at any given time.

Ducting - Round Flexible & Rigid

Aluminium Flexible Ducting

Aluminium Flexible Ducting Hose

Cat. No.	Product Type	Size
1010	3 metre	100mm/4"
1011	1.5 metre	120mm/5"
1012	3 metre	120mm/5"
1013	1.5 metre	150mm/6"
1014	3 metre	150mm/6"

Insulated Round Hose

Cat. No.	Product Type	Size
INSDUCT102	10 metre	102mm
INSDUCT127	10 metre	127mm
INSDUCT152	10 metre	152mm

Aluminium Laminated Flexible Ducting

Aluminium Flexible Hose

Cat. No.	Product Type	Size
1050	102mm Aluduct - 10 metre	100mm 4"
1060	127mm Aluduct - 10 metre	125mm 5"
1070	152mm Aluduct - 10 metre	150mm 6"
1071	200mm Aluduct - 10 metre	200mm 8"
1080	250mm Aluduct - 10 metre	230mm 9"
1090	315mm Aluduct - 10 metre	300mm 12"

Rectangular PVC Flexible Ducting

3m Rectangular Flexible Hose

Cat. No.	Product Type	Size
10212	3 metre - 110 x 54mm	100mm/4"
10255	3 metre - 150 x 70mm	125mm/5"
10252	3 metre - 204 x 60mm	125mm/5"
10263	3 metre - 220 x 90mm	150mm/6"

Acoustic Round Duct

Cat. No.	Product Type	Size
SOUNDUCT102	100mm 4" - L10m	100mm 4"

PVC Flexible Ducting

PVC Flexible Ducting Hose

Cat. No.	Product Type	Size
3761	1 metre	80mm/3"
37615	15 metre	80mm/3"
101025	1 metre	100mm/4"
1020	3 metre	100mm/4"
1021	3 metre	100mm/4"
1024	6 metre	100mm/4"
1025	4 metre	120mm/5"
1026	5 metre	150mm/6"
10410	10 metre	100mm/4"
10415	15 metre	100mm/4"
1023	45 metre	100mm/4"
10251	1 metre	120mm/5"
5753	3 metre	120mm/5"
1030	4 metre	120mm/5"
5756	6 metre	120mm/5"
10510	10 metre	120mm/5"
10515	15 metre	120mm/5"
1068	45 metre	120mm/5"
10253	1 metre	150mm/6"
6763	3 metre	150mm/6"
1040	5 metre	150mm/6"
6766	6 metre	150mm/6"
10610	10 metre	150mm/6"
10615	15 metre	150mm/6"
8786	6 metre	200mm/8"
87815	15 metre	200mm/8"

Round Pipes - PVC

Cat. No.	Product Type	Size
41350	100mm - L350	100mm/4"
41500	100mm - L500	100mm/4"
41900	100mm - L1000	100mm/4"
41915	100mm - L1500	100mm/4"
42000	100mm - L2000	100mm/4"
51350	120mm - L350	120mm/5"
51500	120mm - L500	120mm/5"
51900	120mm - L1000	120mm/5"
51915	120mm - L1500	120mm/5"
52000	120mm - L2000	120mm/5"
61350	150mm - L350	150mm/6"
61500	150mm - L500	150mm/6"
61900	150mm - L1000	150mm/6"
61915	150mm - L1500	150mm/6"
62000	150mm - L2000	150mm/6"
40420	4" Round Pipe clip	100mm/4"
50520	5" Round Pipe clip	120mm/5"

Round Sleeve Pipe

Creates Telescopic Assembly with Round Pipe

Cat. No.	Product Type	Size
SPIPE4	Round Pipe Sleeve - 1m	100mm/4"
SPIPE5	Round Pipe Sleeve - 1m	120mm/5"
SPIPE6	Round Pipe Sleeve - 1m	150mm/6"

Round Pipe Telescopic Assembly

Cat. No.	Product Type	Size
TPIPE4	250mm to 450mm	100mm/4"
TPIPE5	250mm to 450mm	120mm/5"
TPIPE6	250mm to 450mm	150mm/6"

Round Pipe Connectors

For use with PVC/Aluminium Ducting

Cat. No.	Product Type	Size
414C	Connector/PVC	100mm/4"
515C	Connector/PVC	120mm/5"
616C	Connector/PVC	150mm/6"
414CD	Connector with Damper	100mm/4"
616CD	Connector with Damper	150mm/6"
1091	Connector/Aluminium	100mm/4"
1092	Connector/Aluminium	120mm/5"
1093	Connector/Aluminium	150mm/6"
10918	Connector/Aluminium	200mm/8"
10919	Connector/Aluminium	230mm/9"
10912	Connector/Aluminium	300mm/12"

T piece Connectors

PVC/Aluminium to connect Round Ducting

Cat. No.	Product Type	Size
44920	T Piece/PVC	100mm/4"
44930	T Piece/PVC	120mm/5"
44940	T Piece/PVC	150mm/6"
1094	T Piece/Aluminium	100mm/4"
1095	T Piece/Aluminium	120mm/5"
1096	T Piece/Aluminium	150mm/6"
10948	T Piece/Aluminium	200mm/8"
10943	T Piece/Aluminium	300mm/12"

Y piece Connectors

PVC to connect Round Ducting

Cat. No.	Product Type	Size
44950	Y Piece/PVC	100mm/4"
44960	Y Piece/PVC	120mm/5"
44970	Y Piece/PVC	150mm/6"

90° Bend

Connectors for Round Pipe Systems

Cat. No.	Product Type	Size
44900	Connector/PVC/90°	100mm/4"
55900	Connector/PVC/90°	120mm/5"
66900	Connector/PVC/90°	150mm/6"

Ducting - Round Rigid & Accessorieies



45° Bend

Connectors for Round Pipe Systems

Cat. No.	Product Type	Size
44450	Connector/PVC/45°	100mm/4"
55450	Connector/PVC/45°	120mm/5"



Threaded Hose Connectors

Hose Connector for Round Pipe system & Flexi Hose

Cat. No.	Product Type	Size
4124M	100mm - Male	100mm/4"
4126F	100mm - Female	100mm/4"
5124M	120mm - Male	120mm/5"
5126F	120mm - Female	120mm/5"
6124M	150mm - Male	150mm/6"



Insulated PVC Round Pipe

Cat. No.	Product Type	Size
IJRP41915	1.5m Length	100mm
IJRP42000	2.0m Length	100mm
IJRP51915	1.5m Length	125mm
IJRP52000	2.0m Length	125mm
IJRP62000	2.0m Length	150mm
IJ125-1.5	1.5m Length Jacket	125mm
IJ100-2	2m Length Jacket	100mm
IJ125-2	2m Length Jacket	125mm
IJ150-2	2m Length Jacket	150mm



Insulated Bend

Cat. No.	Product Type	Size
IJB44450	45° PVC Bend	100mm
IJB44900	90° PVC Bend	100mm
IJB55450	45° PVC Bend	125mm
IJB55900	90° PVC Bend	125mm
IJB66900	90° PVC Bend	150mm
IJ125-45	45° PVC Bend Jacket	125mm
IJ125-90	90° PVC Bend Jacket	125mm



Insulated T-Piece

Cat. No.	Product Type	Size
IJTP44920	T-Piece	100mm
IJTP44930	T-Piece	125mm
IJTP44940	T-Piece	150mm
IJT125	T-Piece Jacket	125mm
IJT150	T-Piece Jacket	150mm



Round Wall Plate

Cat. No.	Product Type	Size
41140	154 x 154mm	100mm/4"
51140	172 x 172mm	120mm/5"
51145	200 x 200mm	150mm/6"

Condensation Traps

Condensation Trap with Overflow.



Cat. No.	Product Type	Size
1440*	Condensation Traps	110mm/4"
1450	Condensation Traps	125mm/5"
1460	Condensation Traps	150mm/6"

*If using with 100mm ventilation ducting, use adapter 40419.



Flat Channel Clip

Cat. No.	Product Type	Size
41220	110 x 54mm	110 x 54mm
58220	150 x 70mm	150 x 70mm
51220	204 x 60mm	204 x 60mm



Duct Support Clip

For use with Flat Channel Ducting

Cat. No.	Product Type	Size
60922	Duct support clip	220x90mm
1680	Duct support clip	225x25mm/ 300x25mm



In-Line Backdraught Shutter

Can be mounted onto the spigot of the 4" / 5" / 6" XF, SF fans or In-Line in the ducting

Cat. No.	Product Type	Size
1230	In-Line backdraught Shutter	100mm/4"
1231	In-Line backdraught Shutter	120mm/5"
1232	In-Line backdraught Shutter	150mm/6"



Metal Clamps

Metal Worm Drive Clamps 8mm wide

Cat. No.	Product Type	Size
1100	50mm - 110mm	100mm/4"
1110	60mm - 165mm	120mm/5"
1120	60mm - 325mm	150mm/6"



Tapes

Self-Adhesive Tapes

Cat. No.	Product Type	Size
11405W	PVC Tape - White	50mmx5m
1140	PVC Tape - Grey	50mmx10m
1140W	PVC Tape - White	50mmx10m
114033W	PVC Tape - White	50mmx33m
1130	Aluminium Tape	50mmx45m



Spares

Cat. No.	Product Type
1310	TDI Replacement Timer Boards
1340	Replacement Pullcord switches
1345	Extra Long Pullcord switches

Ducting - Kits

Wall Outlets available in White & Brown - Please state colour when ordering.

Window Vent Kits

Cat. No.	Product Type	Size
1269	Window Vent Kit for XF100 Fans	100mm/4"
	Complete with External Backdraught Shutters	
12691	As above with Fixed Louvre Grille for XF100A Fans	100mm/4"
1267	Window Vent Kit for XF120 Fans	120mm/5"
	Complete with External Backdraught Shutters	
12671	As above with Fixed Louvre Grille for XF120A	120mm/5"
1268	Window Vent Kit for XF150 Fans	150mm/6"
	Complete with External Backdraught Shutters	
12681	As above with Fixed Louvre Grille for XF150A	150mm/6"

Duct Kit

400mm Wall Vent Kit for the WF Series / Aluminium Wall Liner

Cat. No.	Product Type	Size
1301	for WF230 Series	230mm/9"
1299	for WF300 Series	300mm/12"

Wall Vent Kits

Kits complete with Aluminium Flexible Ducting & External Wall Grilles in White, Grey, Brown, Terracotta & Cotswold Stone (380mm length)

Cat. No.	Product Type	Size
1270	XFFK for XF100 range	100mm/4"
1280**	SVK for XF150 range	150mm/6"
1290**	AVK for XF150A range	150mm/6"
1291*	SVK for XFS230 range	230mm/9"
1292*	SVK for XFS 300 range	300mm/12"

*Product supplied with Plate Grilles. **Available in White only.

Tumble Dryer Venting Kit

With White Gravity Grille

Cat. No.	Product Type	Size
41703	Tumble Dryer Kit 100mm	100mm/4"

Indoor Tumble Dryer Vent Kit

Cat. No.	Product Type	Size
41704	Tumble Dryer Kit	100mm/4"

Tumble Dryer - Venting Kit

With Cowled Grille

Cat. No.	Product Type	Size
7207	Rectangular Tumble Dryer Kit 100mm	100mm/4"
7208*	Round Tumble Dryer Kit 100mm	100mm/4"

*Available in White only.

Cooker Hood - Venting Kit

With Gravity Grille

Cat. No.	Product Type	Size
43077	Cooker Hood kit 120mm	120mm/5"
43078	Cooker Hood kit 150mm	150mm/6"

High Rise Installation Kit

With Round Cowl Outlet

Cat. No.	Product Type	Size
72447	Round Pipe 100mm	100mm/4"

Telescopic Outlet Set

With Weatherproof Cowl

Cat. No.	Product Type	Size
7108	Round Pipe 250mm to 450mm	100mm/4"
7508*	Round Pipe 250mm to 450mm	120mm/5"
7608*	Round Pipe 250mm to 450mm	150mm/6"

*Available in White only.

Telescopic Return Air Box Set

With Fixed Grille

Cat. No.	Product Type	Size
7616	Round Pipe 250mm to 450mm	150mm/6"

Weatherproof Cowl Kit

1m Round Hose with Weatherproof Cowl

Cat. No.	Product Type	Size
7204	1m Round Hose kit	150mm/6"

Gravity Grille Kit

1m Round Hose with Gravity Grille

Cat. No.	Product Type	Size
7205	1m Round Hose kit	100mm/4"
7216*	1m Round Hose kit	120mm/5"
7217	1m Round Hose kit	150mm/6"

*Available in White only.

Fixed Grille Kit

1m Round Hose with Fixed Grille

Cat. No.	Product Type	Size
7218*	1m Round Hose kit	100mm/4"
7215	1m Round Hose kit	120mm/5"
7220	1m Round Hose kit	150mm/6"

*Available in White only.

Flat Channel Ducting Kit

With Weatherproof Cowl and Horizontal Bend

Cat. No.	Product Type	Size
7212	3m Flat Channel Ducting Kit	100mm/4"

Round Pipe Ducting Kit

With Cowled Outlet & 90° Bend

Cat. No.	Product Type	Size
72605	3m Round Pipe Ducting	150mm/6"

Ducting - Fire Stopping

Fire Seals

For Flat Channel Ducting & Round Pipes



Cat. No.	Product Type	Duct Size
FS110D*	Fire seal	110mm
FS204D*	Fire seal	204mm
FS300D*	Fire seal	300mm
FSC204*	Fire Seal Cage	204mm



FCR110N*	Rectangular Fire Sleeves	110x54mm
FCR204N*	Rectangular Fire Sleeves	204x60mm
FCR220N*	Rectangular Fire Sleeves	220x90mm.



FCSC100N*	Round fire sleeves	100mm
FCSC125N*	Round fire sleeves	125mm
FCSC150N*	Round fire sleeves	150mm
FCR204X3	Fire Sleeve - 3 sided	204x60



Metal Valves & Metal Fire Valves*



Cat. No.	Product Type	Size
1250M	Metal Valves	100mm/4"
1251M	Metal Valves	125mm/5"
1260M	Metal Valve (available shortly)	150mm/6"
FV1250*	Metal Valve rated to 60mins	100mm/4"
FV1251*	Metal Valve rated to 60mins	125mm/5"
FV1260*	Metal Valve rated to 60mins	150mm/6"

Fire Dampers

Can be mounted vertically or horizontally, and have a one hour fire rating in both directions



Cat. No.	Product Type	Size
1261*	Fusible Link Fire Damper	100mm/4"
1262*	Fusible Link Fire Damper	120mm/5"
1263*	Fusible Link Fire Damper	150mm/6"

*Manrose Manufacturing Ltd does not guarantee compliance with Building Regulations Part B, Fire Spread or other regulations that relate to fire planning. Suitability to comply with these regulations should be determined prior to installation and in conjunction with Building Control Officers. Compliance with the Regulations is specifically excluded from quotations and designs.

MANROSE®

Manrose
Unit 23, Suttons Park Avenue
Earley, Reading, RG6 1AZ

Telephone: 01753 691399

Facsimile: 01753 692294

Email: sales@manrose.com

www.manrose.co.uk

Free Fax Order Line: 0800 387646

For further information on any product, please
contact our Technical Department

Telephone: 01753 876941

Email: technical@manrose.com



ISO 9001 accredited

