

FRESH 100/100-dB INSTALLATION

Fresh
www.freshvent.com

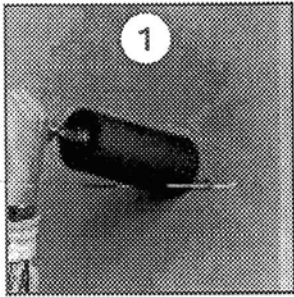

- Use a hole cutter, minimum \varnothing 100 mm (Fresh 100) or minimum \varnothing 150 mm (Fresh 100-dB) and drill from inside to out so that the pipe will be slightly angled down towards the outside.
- For walls thicker than 320 mm an additional pipe module must be used.
- For walls less than 320 mm thick, the pipe should be cut to the correct length.
- The sound dampening pipe can be easily cut to the required length using a knife or saw.

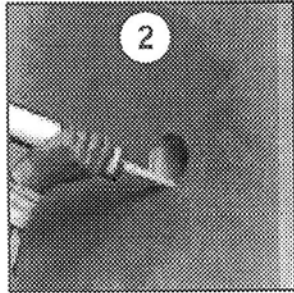

- Insert the pipe and seal the outer gap with the wall at both ends using a silicone sealant.

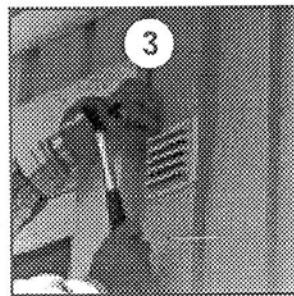

- Nail or screw the external wall grill/canopy in place on the outside wall.

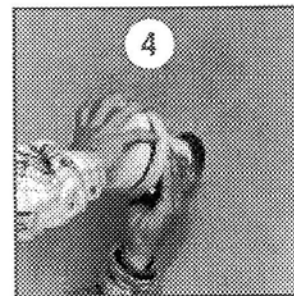

- Open the vent. Press the vent cover in and turn it clock wise. Remove the filter holder and filter.

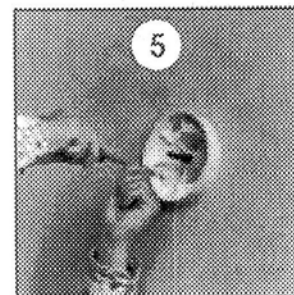

- Screw the vent housing in place with 4 screws.

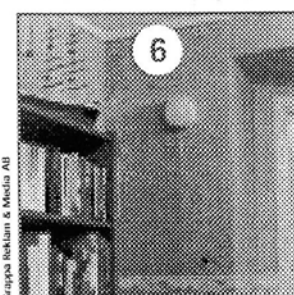

- Replace the filter and filter holder. Press the vent cover in place and turn it anti-clockwise. Installation of the vent is now complete.

Fresh 100

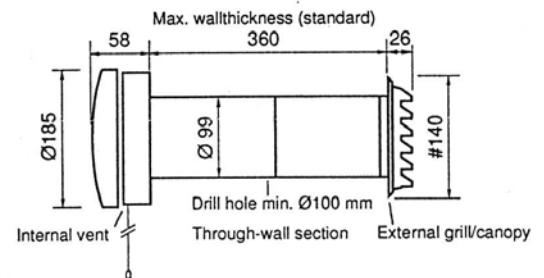

Fresh 100-dB

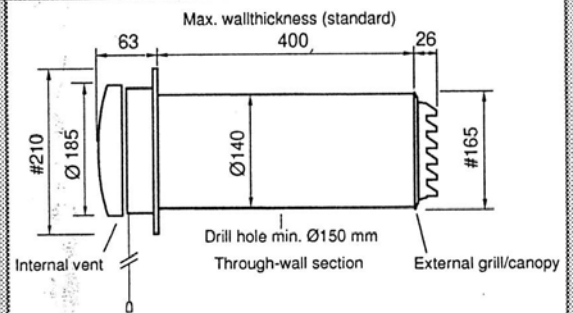

PLACEMENT

- As high up on the wall as possible, but at least 10 cm under the ceiling.
- Above, or directly connected to the window. For areas with underfloor heating the vent should be placed at least 1 metre from the window and should be complemented with the air deflector (accessories).
- Avoid drilling holes in partition studs or close to electrical cables and water pipes.

MAINTENANCE

On the inside the vent is fitted with a filter that should be cleaned in water (add washing-up liquid if necessary) once or twice per year. Set the vent in the open position. Press in and then turn the vent cover clockwise. Remove the vent cover and filter holder and the filter is accessible.

Vent cover insulates against condensation and noise.

Calibration screw for infinitely variable adjustment of air opening between 0 - 17 mm.

Dust and insect filter as standard. Other filters are available as optional extras.

