

**zehnder**

always the  
best climate

- Decorative Radiators
- **Comfortable indoor ventilation**
- Heating and cooling ceiling systems
- Clean air solutions



Always the best climate for

# PERFORMANCE

The new generation of MVHR units - ComfoAir Q

Zehnder has everything you need for optimum indoor ventilation for every project.

Zehnder ComfoAir Q is the NEW generation of heat recovery ventilation units, with state of the art design and intelligent technology, regardless of whether you are working on a new build or an old building, with Zehnder comfortable ventilation you have an innovative, tried and tested complete system.

## Contents

Pages 4-5	Product Specifications
Pages 6-9	Innovations and Design
Pages 10-13	System Integration and Controls
Pages 14-15	Air Distribution
Pages 16-19	Performance
Pages 20-21	Product Comparisons
Page 22	Contact Information



## Zehnder ComfoAir Q

With Zehnder ComfoAir Q, you are provided with the highest level of living comfort. The innovative ventilation units contribute significantly to comfortable room ventilation, quiet in operation, ensure healthy, dust-free air and protect against excessive humidity.

Zehnder ComfoAir Q350

Zehnder ComfoAir Q450

Zehnder ComfoAir Q600



### Specification

- World class heat recovery of 96%
- 3 models available - 350m<sup>3</sup>/hr, 450m<sup>3</sup>/hr and 600m<sup>3</sup>/hr
- Suitable for medium and large size properties:
  - Q350 - up to 250m<sup>2</sup>\*
  - Q450 - up to 300m<sup>2</sup>\*
  - Q600 - up to 350m<sup>2</sup>\*
- All units have been certified as an official Passive House component by the Passivhaus Institute
- Left or right hand unit configuration combined in one device for installation flexibility

\* System pressure needs to be <200Pa. Additional attenuation may be required.

### Dimensions

All measurements in mm unless otherwise indicated

Dimensions are the same across all models

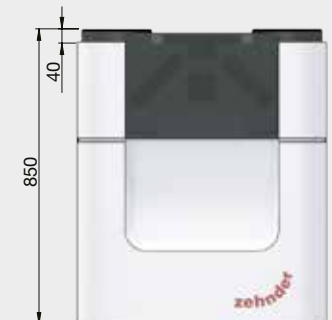
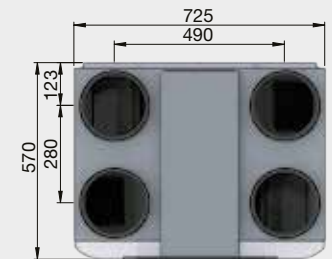

### Passive House Certified



Passive House is an internationally recognised standard for high quality, low energy buildings.

The standard requires that only those components which have been rigorously tested and approved can be used within the building. It is imperative when building to a Passive House specification that certified MVHR units are used, as poorly performing, uncertified products which don't live up to their claims can disrupt the performance of the whole property. Meeting stringent Passive House standards for quality, performance and energy efficiency, all three Zehnder ComfoAir Q units have been independently tested and certified by the Passive House Institute ensuring reliable and effective performance with minimum running costs.



Winner of the iF award 2017

### Physical Specification

- Spigot size:
  - 160mm: Q350
  - 180mm: Q450/Q600
- Fans: EC with Zehnder flow control
- Filters: G4/G4 or G4 extract F7 supply
- On board LCD display
- Mounting bracket for wall fixing or free standing on mount
- Weight: 50kg
- Power lead complete with 3 pin plug
- Condensate connection (32mm) comes with options of both a threaded or socket weld attachment
- Dust caps to prevent dust ingress during second fix
- ComfoAir Q models with pre-heater and enthalpy cube are also available

## Driving system performance through innovation

Zehnder ventilation systems innovative technology make for less complexity, increased heat recovery efficiency, lower specific fan power and significant noise reduction.

A perfect combination of outstanding technical performance and excellent features makes ComfoAir Q the best in class achieving top efficiency ratings.

### Heat recovery performance

Heat Recovery Performance is an important factor in unit specification as it has a direct impact on the heating load and offers savings to the homeowner.

When comparing two MVHR units with 87% and 94% heat recovery efficiency you can achieve up to a 25% reduction in heating costs (from ventilation loss) if selecting the higher performing unit.



### Unique, ultra-powerful heat exchanger – for maximum energy efficiency

The unique diamond heat exchanger features an especially large surface, which allows it to achieve a higher level of efficiency. Variable channel heights ensure a constant flow and lower pressure loss. As a result, less energy is required to overcome the air resistance.

### Noise reduction

Did you know that for every increase of 3dB (A) the sound power is doubled?

ComfoAir Q's sound performance of 28\*dB(A) means one competitor unit is equivalent to 8 ComfoAir Q units in operational noise!

### Innovative air volume balancing – for maximum heat recovery

New and patented: innovative sensor technology automatically ensures balanced supply air and extract air volumes. This flow control guarantees maximum heat recovery. What's more, you save time during commissioning because of the unit's dial-a-duty feature where the required air flow is input and the unit will automatically adjust the motors to achieve this.

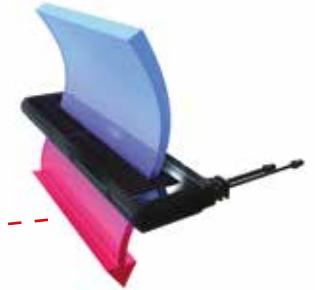

### Intelligent temperature control of the intake air – for the best possible energy efficiency

The pre-heater adapts its operation taking into consideration temperature, air flow and humidity to ensure consistent supply air temperature is achieved no matter what is going on outside. Thanks to its large surface and delta shape, the level of pressure loss is negligible – and that also reduces the power consumption.



### State-of-the-art fan technology – for quiet, energy-saving operation

The flow grid, scroll housing and impeller ensure the best possible air flow. This not only means an extremely quiet operation, but also particularly low power consumption. A high-quality, future-proof solution, based on tried-and-tested technology.

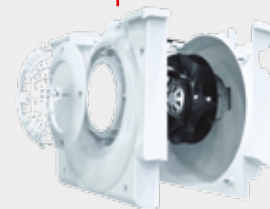

## Ensuring the best in class for heat recovery efficiency, noise and energy performance

ComfoAir Q is easy to design, simple to install and provides optimum comfort levels to the home throughout the year thanks to its innovative performance focused design.

### Ensures optimum comfort through the modulating by-pass

The modulating inline by-pass adapts to the outside temperature, to ensure ideal comfort conditions regardless of the outdoor temperature, minimising heat loss in the process.

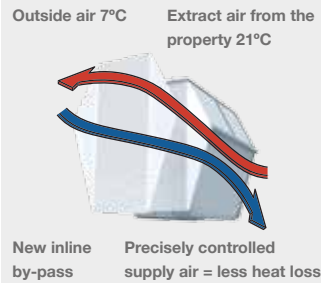

### Efficient fan guarantees an improved performance, with less energy consumption

The powerful fan generates more power with less energy consumption. Optimum airflow through the flow grid and scroll housing means that the energy consumption for overcoming the air resistance is low. Sensor technology also ensures that the speed is only adapted if a permanent change is made, ensuring energy and cost savings (Specific Fan Power of just 0.53 w/l/s for the Zehnder ComfoAir Q 350/450).

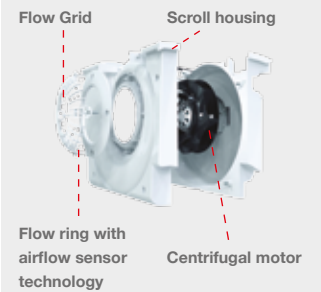

### Improving air quality through filtration

Healthy air is another important feel-good factor. As a result, the new filter concept reduces the amount of dust in the unit and air distribution system. Filters are available in two grades, G4 and F7 each with a pleated design for optimum filtration. Maintenance is easy with the warning indicator on the start-up wizard to indicate when filters may need attention or changing.

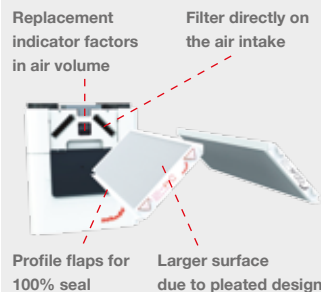

## Adaptable for each unique installation

The intuitive start up wizard offers a simple installation process on-site including left and right hand configuration in one single unit.

Flexibility is at the heart of ComfoAir Q.

### Installation wizard facilitates ease of set-up

The start-up wizard guides you step by step through the set up process including an automatic self-test. Using the design drawings you can simply type in the required airflow rates for low, medium and boost and the system automatically sets these across the installed system.



### On-site interchangeable orientation

Right and left handing can be modified on-site easily when required helping save time and money on-site and reducing risk of incorrect installations.



### Ensuring an optimum room temperature - at all times

The most important feel-good factor is comfort, through regulation of temperature and humidity. Zehnder ComfoAir Q's intelligent temperature control factors in the varying outdoor temperature at different times of the year, to ensure ideal comfort conditions indoors.

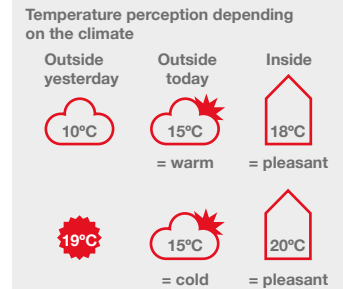

## The ideal ventilation unit for every project

There is a Zehnder ventilation unit and indoor ventilation solution for every area of use. Combined with other components, they form the optimum system.



### Zehnder option box

Provides additional connectivity options

### Zehnder ComfoConnect KNX C

Provides KNX connectivity options

### Zehnder ComfoConnect LAN C

Provides LAN connectivity options for remote control



### Zehnder ComfoFond-L Q

#### Sub soil heat exchanger (or regulated sub-soil heat exchanger)

Pre-conditions the temperature of the outdoor airflow before it enters the unit. This ancillary is connected to the Option Box. (see page 12)

- Uses the constant temperature of the soil for heat recovery and to control the temperature of the air
- Sustainable use of geothermal energy
- Saves having to use a pre-heater in winter, supplies tempered supply air in the summer

### Zehnder ComfoCool Q600

#### Air Tempering Unit

ComfoCool helps to reduce humidity along with the intake air temperature to help improve the internal environment and comfort levels. It is easily integrated into the ventilation system to provide filtered fresh supply air whilst consuming a low amount of energy and at low noise levels.

- Cooling is automatically activated by a user defined comfort temperature in combination with monitoring both intake air and internal air temperatures.
- Equipped with a compression cooling system, as is used in refrigerators to reduce the temperature, in this case of the incoming supply of filtered air.
- Differs from traditional air-conditioning by using the air performance of our MVHR system to deliver the available cooling power.

### Zehnder ComfoWell

#### Air Distribution Manifold and Attenuator

- All air treatments available: attenuator, fine filter, active carbon filter, manifold box
- Modular design
- High levels of sound attenuation
- Components connected with locking slides for easy mounting
- Directly connected to all components of the ComfoWell system
- Easy to clean

### Zehnder ComfoAir Q Pre-Heater

Increases the temperature of the outdoor airflow in order to protect the heat exchanger against frost.

- Accurate modulation based on flow rate and temperature
- Interchangeable (left/right)
- Low resistance
- Tilt switch: orientation defines left/right unit
- No mounting errors

## Simply making every step easier

Easy, reliable plug-and-play installation, guidance through commissioning, easy maintenance and remote monitoring. Combine several devices with the ComfoAir Q unit to extend possibilities.

## Easy operation from switch to app

App



Display



Controllers



Anything is possible – from a simple display on the unit, to a practical app that can be used on the go, right through to fully automated, demand-based ventilation using sensors. You can also integrate Zehnder ComfoAir Q into a building control system via the KNX interface.

## A range of control options

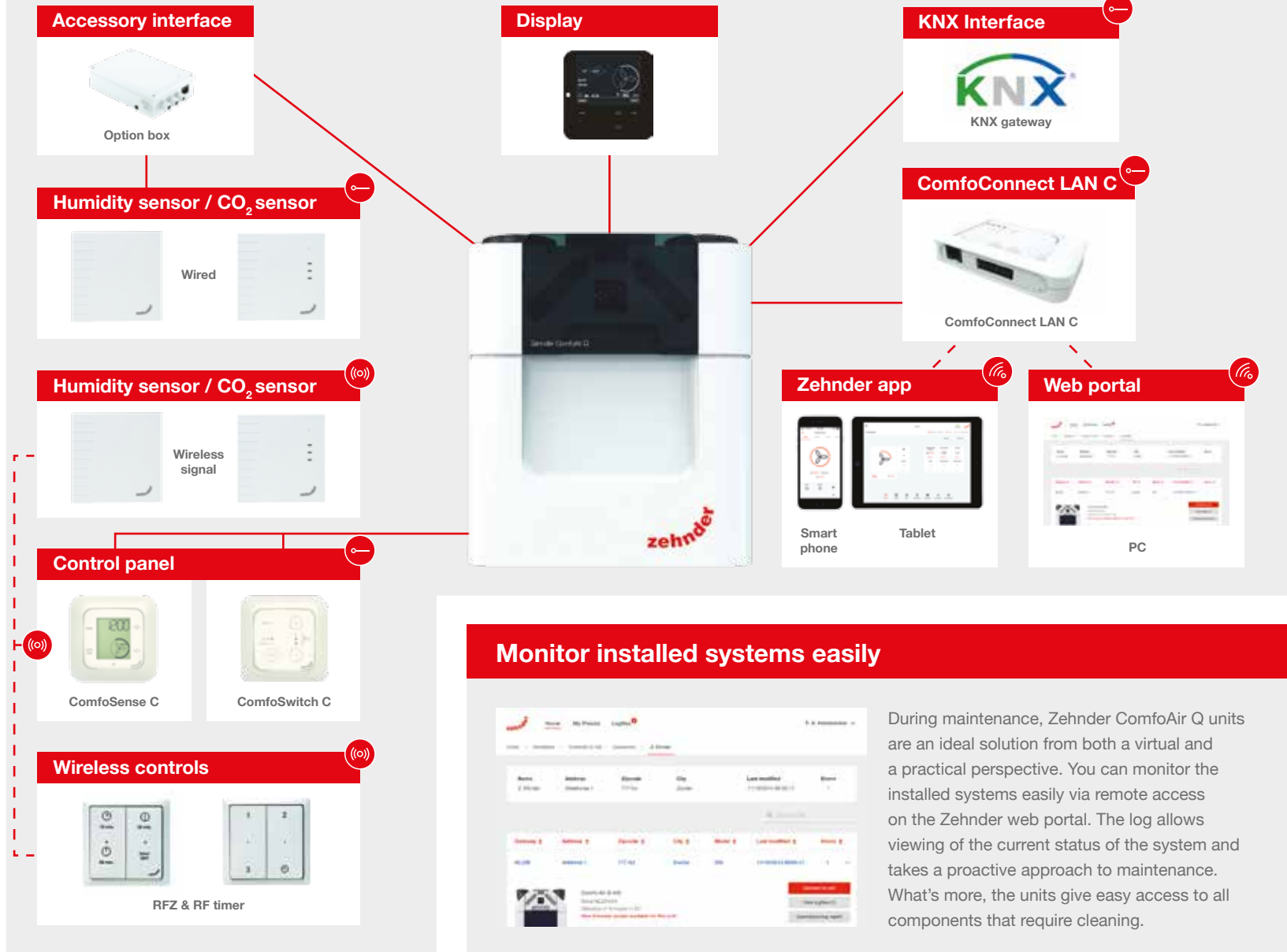

## Monitor installed systems easily

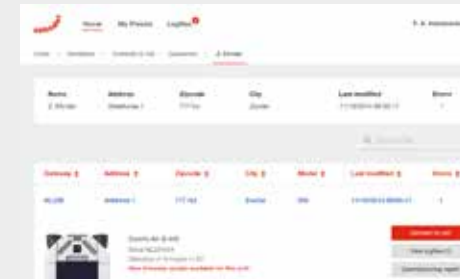

During maintenance, Zehnder ComfoAir Q units are an ideal solution from both a virtual and a practical perspective. You can monitor the installed systems easily via remote access on the Zehnder web portal. The log allows viewing of the current status of the system and takes a proactive approach to maintenance. What's more, the units give easy access to all components that require cleaning.

## Perfect integration

With a full range of components designed to work together, Zehnder ComfoAir Q can be integrated into a home simply and effectively to provide fresh air and comfort.

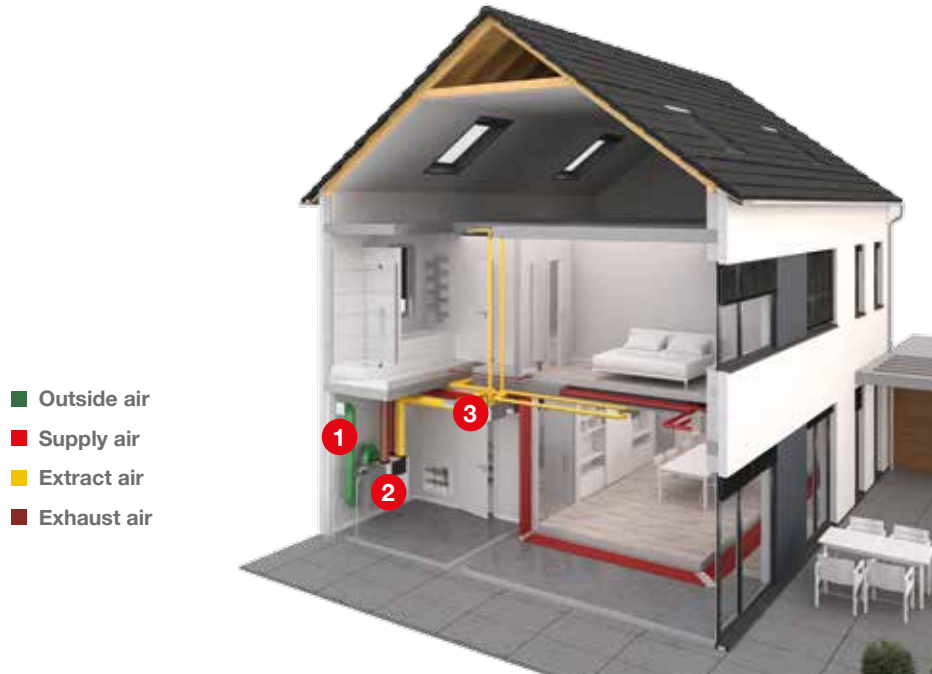

- Outside air
- Supply air
- Extract air
- Exhaust air

## How it works

### 1. Supply of fresh air:

Fresh air is fed into the system via an external wall vent. The fresh outside air can optionally flow through a sub-soil heat exchanger beforehand which uses geothermal energy to pre-temper the outside air.

### 2. Ventilation unit:

Up to 96% of the heat is recovered from the extract air and transferred to the fresh air. This can be humidified, dehumidified, heated and cooled using optional components.

### 3. Air distribution:

The air distribution system channels fresh air at the right temperature to individual rooms as needed and vents the extract air to the outside. The air volume can be individually adjusted for each room.

## Easier, more efficient and more comfortable

Ventilation systems from Zehnder ensure the legally required minimum air exchange, lower heating costs and provide for a comfortable indoor climate all the year round. Over 40 years' experience developing and producing form the basis for Zehnder complete systems. The individual components, intelligently designed to work together, are characterised by the highest level of functionality and durability. With Zehnder ComfoAir Q, Zehnder is launching a new generation of ventilation units: Thanks to optimum design and coordination of the main components, they offer the best in sound power level values and particularly low energy consumption.

## Zehnder ComfoFresh air distribution system

**Hygienic and clean:** in addition to the ventilation unit, the air distribution system also plays an essential role in the optimum functionality of comfortable indoor ventilation: it influences ventilation performance, noise level, appearance, energy efficiency, hygiene and ease of maintenance.

Clinside, the smooth inner skin of the ventilation tubes prevents the build-up of dust. Only minimal maintenance is required for optimal operation.

The air distribution system is SKZ certified and approved by the Hygiene Institute.

- The air distribution system can be incorporated into ceilings, walls and floors using round tubes, flat tubes, or a combination of the two - a sophisticated system for any situation
- Perfectly matched components for every installation situation
- ComfoPipe Plus outdoor and exhaust air connections with optimum insulation
- Designer grille for harmonious integration into any setting





## Data performance tables

Zehnder ComfoAir Q350				
Reference	Airflow [m³/h]	Pa	P [W]	Sound Pressure level @3m [dB(A)]
1	150	25	16	16.0
2	200	50	31	20.1
3	245	50	43	22.6
4	250	100	59	24.9
5	300	100	77	27.6
6	350	100	98	30.5
7	250	150	74	26.9
8	250	200	88	28.9
9	300	200	108	31.0
10	350	200	131	33.4

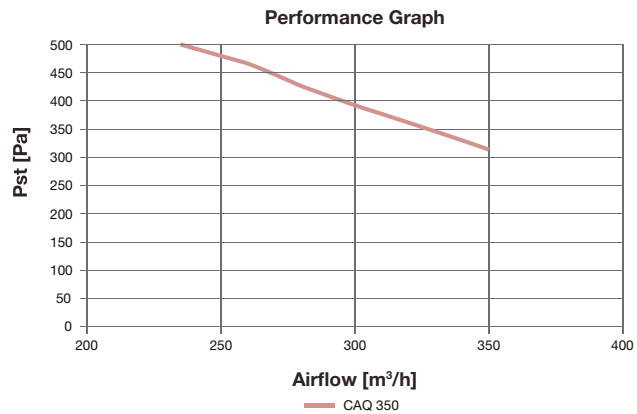
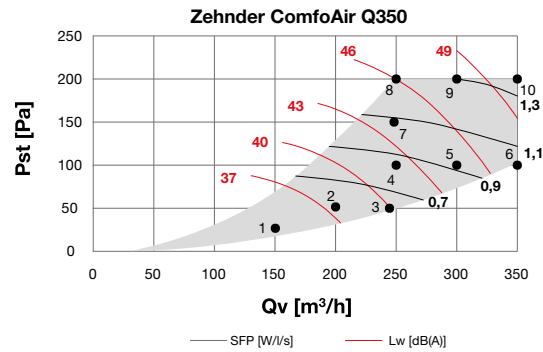

## Data performance tables

Zehnder ComfoAir Q450				
Reference	Airflow [m³/h]	Pa	P [W]	Sound Pressure level @3m [dB(A)]
1	200	25	19	22.0
2	250	50	37	25.0
3	300	50	53	27.3
4	315	50	59	28.0
5	350	100	89	30.8
6	400	100	113	33.1
7	450	100	140	35.6
8	350	140	106	31.9
9	350	200	122	33.0
10	400	200	148	35.2
11	450	200	177	37.5

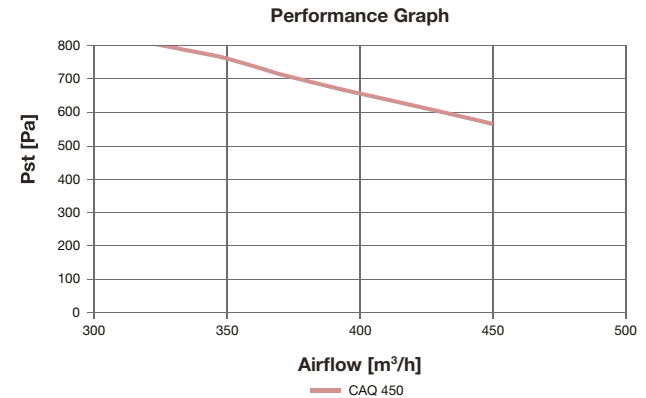
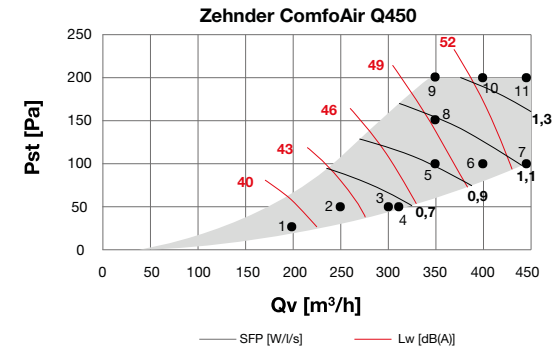

# Data performance tables

# SAP Product Characteristics Database

Zehnder ComfoAir Q600				
Reference	Airflow [m³/h]	Pa	P [W]	Sound Pressure level @3m [dB(A)]
1	250	25	28	26.3
2	300	25	44	28.3
3	350	50	72	30.9
4	400	50	97	33.0
5	420	50	107	33.9
6	450	100	143	35.9
7	500	100	176	38.1
8	600	100	254	42.7
9	450	150	162	36.7
10	450	200	180	37.5
11	500	200	215	39.6
12	600	200	296	43.9

Zehnder ComfoAir Q350				
Exhaust terminal configuration	Specific fan power (W/l/s)	Heat exchange efficiency (%)	Passive House Data	
			Standard heat exchanger	Enthalpy heat exchanger
Kitchen + 1 additional wet room	0.60	96	Airflow range	70–270m³/h
Kitchen + 2 additional wet rooms	0.53	95	Heat recovery rate	ηHR = 90%
Kitchen + 3 additional wet rooms	0.57	94	Specific electric power	$P_{el,spec} = 0.24 \text{Wh/m}^3$
Kitchen + 4 additional wet rooms	0.64	94	Humidity recovery	η <sub>x</sub> = 73%
Kitchen + 5 additional wet rooms	0.72	93		
Kitchen + 6 additional wet rooms	0.89	93		
Kitchen + 7 additional wet rooms	1.03	93		

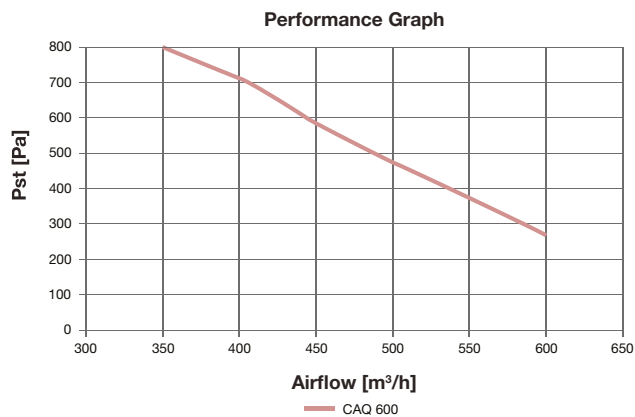
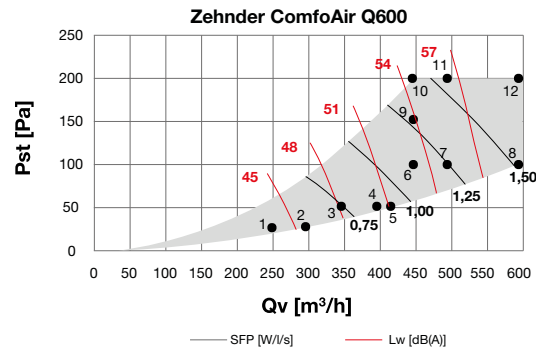

Zehnder ComfoAir Q450				
Exhaust terminal configuration	Specific fan power (W/l/s)	Heat exchange efficiency (%)	Passive House Data	
			Standard heat exchanger	Enthalpy heat exchanger
Kitchen + 1 additional wet room	0.54	96	Airflow range	70–345m³/h
Kitchen + 2 additional wet rooms	0.53	95	Heat recovery rate	ηHR = 88%
Kitchen + 3 additional wet rooms	0.55	94	Specific electric power	$P_{el,spec} = 0.21 \text{Wh/m}^3$
Kitchen + 4 additional wet rooms	0.62	94	Humidity recovery	η <sub>x</sub> = 71%
Kitchen + 5 additional wet rooms	0.73	93		
Kitchen + 6 additional wet rooms	0.86	93		
Kitchen + 7 additional wet rooms	1.04	93		

Zehnder ComfoAir Q600				
Exhaust terminal configuration	Specific fan power (W/l/s)	Heat exchange efficiency (%)	Passive House Data	
			Standard heat exchanger	Enthalpy heat exchanger
Kitchen + 1 additional wet room	0.63	96	Airflow range	70–460m³/h
Kitchen + 2 additional wet rooms	0.60	95	Heat recovery rate	ηHR = 87%
Kitchen + 3 additional wet rooms	0.63	94	Specific electric power	$P_{el,spec} = 0.24 \text{Wh/m}^3$
Kitchen + 4 additional wet rooms	0.71	94	Humidity recovery	η <sub>x</sub> = 68%
Kitchen + 5 additional wet rooms	0.79	93		
Kitchen + 6 additional wet rooms	0.91	93		
Kitchen + 7 additional wet rooms	1.06	93		

# Future-proof solution: easy transition from Zehnder ComfoAir to Zehnder ComfoAir Q

	Zehnder ComfoAir	NEW: Zehnder ComfoAir Q	Your benefits
<b>Planning/Ordering</b>			
<b>Versions</b>	<ul style="list-style-type: none"> <li>Zehnder ComfoAir 350</li> <li>Zehnder ComfoAir 550</li> </ul>	<ul style="list-style-type: none"> <li>Zehnder ComfoAir Q350</li> <li>Zehnder ComfoAir Q450</li> <li>Zehnder ComfoAir Q600</li> </ul>	<ul style="list-style-type: none"> <li>Higher maximum airflow</li> <li>Three units instead of two: optimum system design in projects</li> </ul>
<b>Connections</b>	<ul style="list-style-type: none"> <li>Left-hand or right-hand version</li> </ul>	<ul style="list-style-type: none"> <li>Left-hand and right-hand version in a single unit for adaptation to the installation on site</li> </ul>	<ul style="list-style-type: none"> <li>Always the right unit even when there are last-minute changes</li> <li>Reduced stock levels</li> </ul>
<b>Certificates</b>	<ul style="list-style-type: none"> <li>PHI, DIBT, EPBD, SAP PCDB, NF 205, NEN 5138, EN 308</li> </ul>	<ul style="list-style-type: none"> <li>PHI, DIBT, EPBD, SAP PCDB, NF 205, ERP energy label, NEN 5138, EN 308</li> </ul>	<ul style="list-style-type: none"> <li>Future-proof</li> <li>Worry-free installation</li> <li>Much better figures</li> </ul>
<b>Pre-heater</b>	<ul style="list-style-type: none"> <li>The pre-heater is built into the unit</li> </ul>	<ul style="list-style-type: none"> <li>The pre-heater is easy to retrofit</li> </ul>	<ul style="list-style-type: none"> <li>Easy to retrofit</li> <li>Reduces unit versions</li> </ul>
<b>Installation</b>			
<b>Connections</b>	<ul style="list-style-type: none"> <li>Fixed right/left supply and extract air connection</li> </ul>	<ul style="list-style-type: none"> <li>Supply air and extract air connection easy to switch between right and left</li> </ul>	<ul style="list-style-type: none"> <li>Always the right unit in just a few steps</li> </ul>
<b>Compatibility</b>	<ul style="list-style-type: none"> <li>Zehnder overall system compatible with ComfoAir 350 and ComfoAir 550</li> </ul>	<ul style="list-style-type: none"> <li>Zehnder overall system compatible with ComfoAir Q350, ComfoAir Q450 and ComfoAir Q600 (e.g. air distribution system, ComfoCool Q600, ComfoFond-L Q)</li> </ul>	<ul style="list-style-type: none"> <li>The ventilation unit still matches the air distribution 100%</li> <li>The range of connection components has also been expanded to make installation even easier.</li> </ul>
<b>Commissioning</b>			
<b>Commissioning wizard</b>	<ul style="list-style-type: none"> <li>Manual commissioning via the parameter menu</li> </ul>	<ul style="list-style-type: none"> <li>Commissioning is easy with the start-up wizard which takes you through the simple process step by step</li> </ul>	<ul style="list-style-type: none"> <li>Simple and quick commissioning</li> <li>Reliable system function</li> </ul>
<b>Volume flow balance</b>	<ul style="list-style-type: none"> <li>Fixed fan speed setting during commissioning</li> </ul>	<ul style="list-style-type: none"> <li>Sensor technology guarantees optimum air volume balance</li> <li>Flow Control maintains the set volume flow by automatically adjusting the fan speed</li> </ul>	<ul style="list-style-type: none"> <li>Simple and quick commissioning</li> <li>Maximum heat recovery</li> <li>Comfort for the occupant</li> </ul>

	Zehnder ComfoAir	NEW: Zehnder ComfoAir Q	Your benefits
<b>Maintenance/Use</b>			
<b>Filter concept</b>	<ul style="list-style-type: none"> <li>Standard filter concept</li> <li>Time-based filter alert</li> </ul>	<ul style="list-style-type: none"> <li>Unit filter directly on the air intake</li> <li>Filter flap for an even better seal</li> <li>Larger filter material surface due to it being pleated tighter</li> <li>Intelligent filter alert according to air volume and time</li> <li>Filter change wizard</li> </ul>	<ul style="list-style-type: none"> <li>No build-up of dust in the unit and in the air distribution system</li> <li>Filter replacement as needed thanks to indicator</li> <li>Larger surface means lower pressure loss</li> <li>Lower pressure loss means reduced running costs</li> <li>Simple, error-free filter replacement</li> </ul>
<b>Pre-heater</b>	<ul style="list-style-type: none"> <li>Pre-heater off/on</li> </ul>	<ul style="list-style-type: none"> <li>Pre-heater works in a modulating manner</li> </ul>	<ul style="list-style-type: none"> <li>Optimum energy efficiency thanks to intelligent temperature control of the drawn-in outdoor air</li> <li>Reduced electrical power consumption</li> </ul>
<b>Operating concept</b>	<ul style="list-style-type: none"> <li>No direct operation on the unit possible. For operation with: ComfoSense, 3-position switch, RF, ComfoControl Luxe</li> </ul>	<ul style="list-style-type: none"> <li>Intuitive display on the unit with plain text in the language of the country and a real-time indicator</li> <li>ComfoSwitch C, ComfoSense C, RFZ remote control operation and RF timer, Zehnder ComfoControl app, Zehnder web portal, KNX interface</li> </ul>	<ul style="list-style-type: none"> <li>Easy and convenient operation</li> <li>Individual choice of operating concept</li> <li>Zehnder web portal for easy monitoring via remote access</li> </ul>
<b>User comfort</b>	<ul style="list-style-type: none"> <li>Fixed comfort temperature (can be selected on an individual basis)</li> <li>By-pass switched on or off, 0 or 100%</li> </ul>	<ul style="list-style-type: none"> <li>Adaptive comfort technology: factors in temperature perception according to the outside temperature pattern</li> <li>Modulating by-pass: automatically adjusts heat recovery to calculated comfort temperature</li> <li>One of the quietest ventilation units on the market.</li> </ul>	<ul style="list-style-type: none"> <li>Automatically creates the optimum supply air temperature, for a perfect well-being climate</li> <li>The easy way to ensure a quiet, comfortable indoor climate</li> </ul>

### Terms and conditions of business

A handling charge of £15 will be applied to all orders less than £350 nett.

Standard delivery for stock items is 3 days, subject to availability.

Delivery times for non-stock items can be up to 35 days.

Morning and overnight deliveries are available subject to conditions and will incur a £25 minimum additional charge. Orders must be placed before 11am to be eligible for overnight delivery.

All quotations are valid for 30 days.

The basis for our offer, acceptance of orders, order confirmations or sales contracts is the current valid price list. Sales are subject to our standard terms and conditions which are available on request.

Due to our policy of continuous change and improvement, product specification, price and availability may be subject to change without prior notice.

### © Copyright Zehnder Group UK Ltd 2017

All information believed to be correct at the time of going to press. E&OE. All goods are sold according to Zehnder Group UK Ltd's Standard Conditions of Sales (available on request).

All dimensions are in millimetres unless otherwise shown. Zehnder Group UK reserves the right to change specifications and prices without prior notice.

#### Zehnder Group UK Ltd

Registered office: Unit 4,  
Watchmoor Point, Camberley  
Surrey GU15 3AD  
Registered in England No.2296696

## Contact information

If you need to speak to someone or have a question to ask us, there are several ways of getting in touch.

#### Phone

**Head Office:** 01276 605800

**Customer Services:** 01276 408404

**Technical Services:** 01276 408402

*Fax:* 01276 683315

*Email:* [info@zehnder.co.uk](mailto:info@zehnder.co.uk)

*Website:* [www.zehnder.co.uk](http://www.zehnder.co.uk)